

# ***Haleson***



- 1 Pharma Pumps
- 2 Diaphragm Pumps
- 2 Unloading Systems
- 3 Pharma Valves
- 4 Steriflow
- 5 Steriflow
- 6 Pharma & High Purity Hoses
- 7 Mixers & Agitators
- 8 Tubes & Fittings
- 8 Clamps & Gaskets
- 9 Custom Fabrication
- 10 Tank, Tote & Pipe Cleaning
- 11 Filters & Strainers
- 12 Heat Exchangers
- 13 Instruments

# Pharma Pumps



## UltraPure

Alfa Laval Q-doc documentation package for Alfa Laval UltraPure equipment ensures full traceability of all product contact parts.



**LKH Self-Priming Pump**

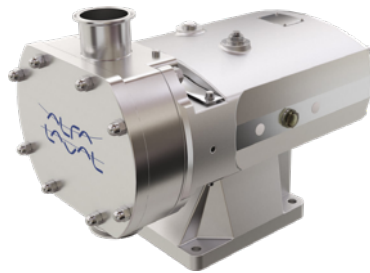

**SX Lobe Pump**



**LKH Centrifugal Pump**



**Jacketed Pumps**



**Labtop Lobe & Peristaltic Pumps**

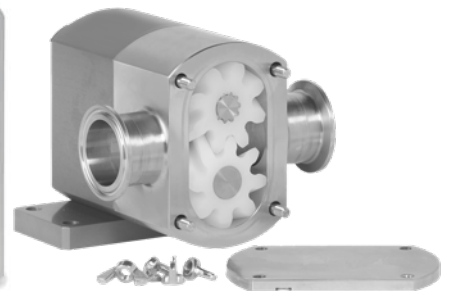

**Gear Pumps**

# Diaphragm Pumps



**ARO**



**MURZAN**



Full Hygienic Pumps  
(Polished Internals)



PTFE/HDPE  
High Purity Pumps



CIP & Chemicals  
Pumps

# Unloading Systems



Tote  
Unloading Pumps



Drum  
Unloading Systems



# Pharma Valves



Q-docs available

Steam Traps & Regulating Valves Available. See our [Steriflow Page](#).



**High Purity**  
Ball Valves



**Ultrapure®**  
Butterfly Valves



**Sampling**  
Valves



**Diaphragm**  
Valves



**Powder Application**  
Valves

# **Steriflow**



**Solutions** that are designed to **improve processes**, production rates, and ultimately, the profitability of healthcare customers. A **complete product range, trusted** by multi-national pharmaceutical companies.



**Control  
Valves**



**Pressure Regulating  
Valves**



**Safety Relief  
Valves**

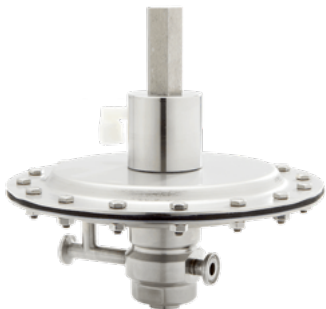

**Low Pressure  
Blanketing Regulators**



**Springless Check  
Valves**



**Sample  
Valves**

# **Steriflow**



## **Built for you**

Steriflow will custom design valves specifically for your process requirements. Unicert documentation included.

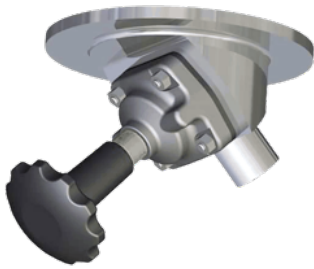

**Tank Bottom**  
Diaphragm Valves



**Custom Block Body**  
Diaphragm Valves



**Multi-Path Diversion**  
Diaphragm Valves



**Clean Steam Traps &**  
SIP accessories



Clean Gas  
**Distribution Manifolds**

# Pharma & High Purity Hoses



**Pharma USP Class VI Hoses**



**Biotech Tubing & Peristaltic Pump Tubing**



**Teflon® Lined Hoses**



**Electrical & Liquid Jacketed Hoses**



**Anti-Static / Grounded Hoses**



**High Quality Washdown Hoses with Microban®**

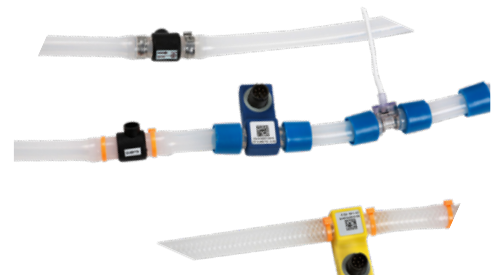

**Single Use Products**



# Mixers & Agitators



**Clamp-on  
Agitators**



**Vertical Shear  
Mixers**



**Side, Top & Bottom  
Entry Mixers**



**In-line Shear  
Mixers**



**Static  
Mixers**



**Powder  
Mixing Systems**



**Tote Mixers**



**Drum Mixers**

# ***Tubes & Fittings***



**BEHRINGER®**



**RathGibson**

**TOP LINE**  
PROCESS EQUIPMENT COMPANY

**Tri-Clover**

**UNITED INDUSTRIES**



**316L & Electropolished  
BPE Tubes in Stock**

**316L & Electropolished  
BPE Fittings in Stock**

**Behringer®  
Clamps & Hangers**

**Jacketed Tubes &  
Fittings**

# ***Clamps & Gaskets***

## **Rubber Fab**

a Garlock Hygienic Technologies company



**Large Selection of  
Gaskets USP Class VI,  
X-Ray Metal Detectable,  
Tuf-Steel, Bio-Pro...**

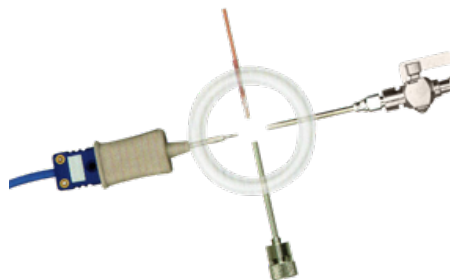

**Sampling Gaskets  
& Accessories**

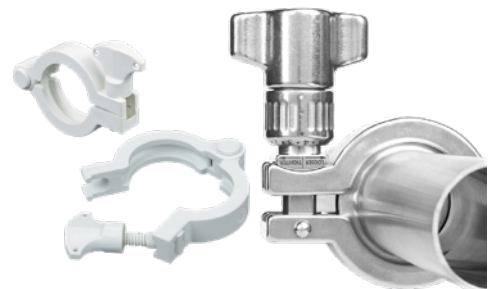

**Nylon Clamps  
& Smart Clamps**

# Custom Fabrication



Components in stock | **Rapid** delivery  
Passivation service available

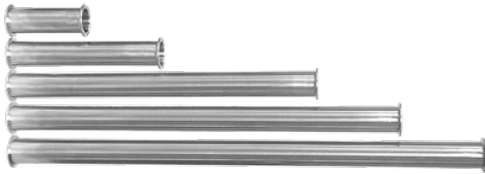

Custom  
**Spool Pieces**



Custom  
**Manifolds**

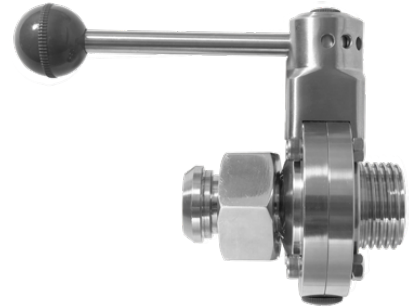

**European Connections**  
in Stock



Custom  
**Tanks**



Custom **Mixing Bowls**  
& **Carts**

# ***Tank, Tote & Pipe Cleaning***



3A Certification available | Q-docs available  
Large Selection & Expertise in pharmaceutical applications



Alfa Laval / Gamajet  
**Jet Machines**



**Rotating  
Spray Balls**



**Product Recovery  
Pigging Systems**



**Multi Vessel  
CIP Systems**



**Mobile  
CIP Systems**

# Filters & Strainers



Q-docs available  
Passivation Available



Wedge Wire & Perforated Plate Filters



Duplex Filters

Jacketed Filters

Basket & Membrane Type  
Filters

# Heat Exchangers



Q-docs available



## Alfa Laval Baseline® Alfa Laval Frontline®

Several Options

- 3A Finish
- PTFE, Nitrile, EPDM Gaskets
- Plates 316L, Titanium, Hastelloy
- Wide Gap
- Double Wall
- Evaporator/Condenser
- Semi Welded
- Welded



**Alfa Laval Shell & Tube Pharmaline**



**Steriflow  
Sample Cooler**



**Alfa Laval  
Pharma X®**



**Alfa Laval Contherm®**  
Viscous Fluids



**AIC JAD®** Excellent for  
Steam, Oil, Hot Water,  
Thermal Fluid

# Instruments



Q-docs available



Sight Glasses



Thermometers



Flow Meters & Non-Invasive Flow Sensors



Manways



Pressure Gauges



Temperature / Pressure Transmitters

# *Haleson*

 Montreal (QC) : 450-686-6663  
Vancouver (BC) : 604-317-1447

 [halesoninc.com](https://halesoninc.com)

 [info@halesoninc.com](mailto:info@halesoninc.com)

 2531, Chomedey Blvd, H7T 2R2,  
Laval, QC, Canada