

ABZ Valves & Controls

A Division of ABZ Manufacturing



Price

Delivery

Quality



GENERAL BROCHURE

ABZ BUTTERFLY VALVES

SERIES 400

Double Offset High Performance Butterfly Valves

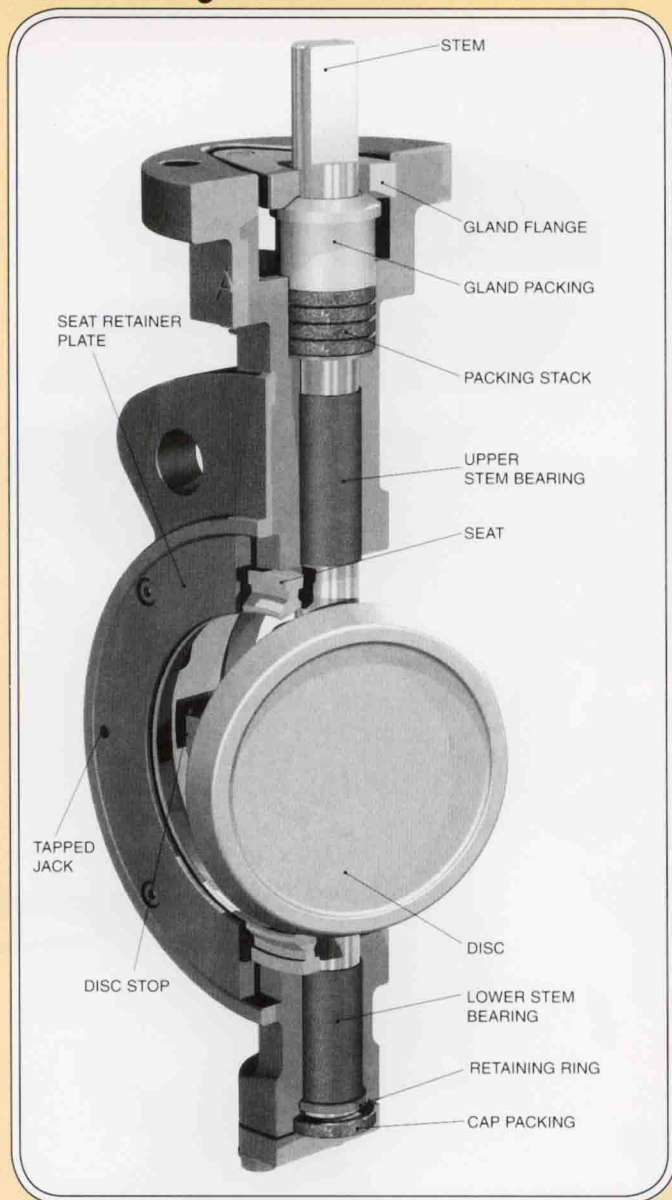

Body

High quality one piece casting which provides consistent uniformity. Body is available in Wafer, Lug, Double Flanged, and Butt-Welded.

Mounting Flange

Designed to direct mount actuation for ease of installation and cost savings. No bracket is needed for manual actuation or for automatic automation up to 24 inch.

Underneath Drawn Gland Packing

Allows for direct mounting of actuation and ease of user adjustment of the gland nuts while method of operation is attached. A rocker design is incorporated to compensate for uneven adjustment of the gland nuts.

Seat

An advanced design that provides a bi-directional interference and pressure assisted seal. This design achieves maximum seal at low, medium and high pressure.

Extended Neck

Allows for two inches of pipe insulation.

Packing

The ABZolute seal High Performance utilizes a cup & cone system of PTFE for soft seated valves and die formed graphite rings for fire safe & metal seated valves. Both of these arrangements assure a positive seal.

Bearings

Made of Graphite impregnated or Reinforced PTFE impregnated 316 Stainless Steel to ensure long service life.

Stem

Manufactured of high strength 17-4 ph Stainless Steel to provide maximum strength and stability for high torque applications.

Disc

Engineered to allow for quick release from the seat. This reduces the amount of torque needed to un-seat the disc.

Disc Taper Pins

Pins are offset from the center of the stem which places them in compression rather than in shear. This gives them a yield point greater than the stem itself. Pins are welded in place after final assembly and testing.

Integrally Cast Disc Position Stop

Machined position stop on the body locates the disc in the seat to achieve maximum seat and seal life.

Bolted in Retainer Plate

Easy field repairability with tapped jack for removing retainer plate.



1. Available in 150, 300 & 600 Class.
2. Available from 2" to 48" standard, larger sizes available.
3. Wide range of trim materials available.

ABZ BUTTERFLY VALVES

FIGURES 909/919

This line of valves is offered with all of our seat materials as well as Encapsulated Disc. This makes it an ideal valve for applications in the Chemical and Food Industries requiring Chemical Resistance or Sanitary features.



1 Bodies are machined to high tolerances. Guaranteed standard dimensions for interchangeability of parts and actuators.

2 Top bushing is impact and corrosion resistant material. Protects the stem from side thrust of actuators.

3 Special double V-shape of stem seal self-adjusts to protect the stem area for either vacuum or pressure use.

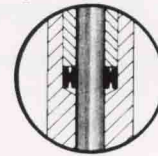

4 Stem and body are isolated from line media by the seal created between the arch surface of the disc (described by the radius of the disc), and the flat surface of the seat.

5 The ABZ Ring Seal on the Teflon® seat is a molded part of the seat. It is of special design so as to contain an o-ring creating a positive seal around the stem as well as between the seat and valve body. This positive secondary seal eliminates leakage into the stem journal as well as migration of line media behind the seat. Teflon® ring seals are located at top and bottom on all Teflon® seated valves.

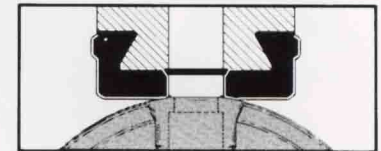

6 The special snap-in Resil-O-Seat™ design fixes seat in place without bonding. The Resil-O-Seat™ is 100% field replaceable — no special tools required. Resil-O-Seat™ is available in a variety of materials including Teflon®.

7 Specially designed disc/stem prevents distortion of disc under high pressure. Thin disc allows for maximum open flow.

8 Two-piece body of figures 909/919 and one-piece disc/stem makes field replacement of seat and disc/stem quick and easy.

9 Disc edge is individually processed through machining for a smooth edge, providing a bubble tight shut-off and maximum seat life.

10 Molded O-ring in the Resil-O-Seat™ forms a seal against all standard ANSI flanges. Gasketing requirements are eliminated.

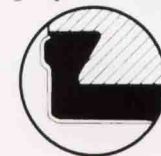

NOTES:

1. Valves rated from 100 to 150 PSI, determined by disc/stem and seat material.
2. Available in sizes 2" through 12"
3. Sizes 2.5" & 5" not available with teflon covered disc.



ABZ BUTTERFLY VALVES

FIGURES 090/929

Resil-O-Seat™ Valves

for Applications in the
Chemical and Food Industries
Requiring Chemical Resistance
or Sanitary Features

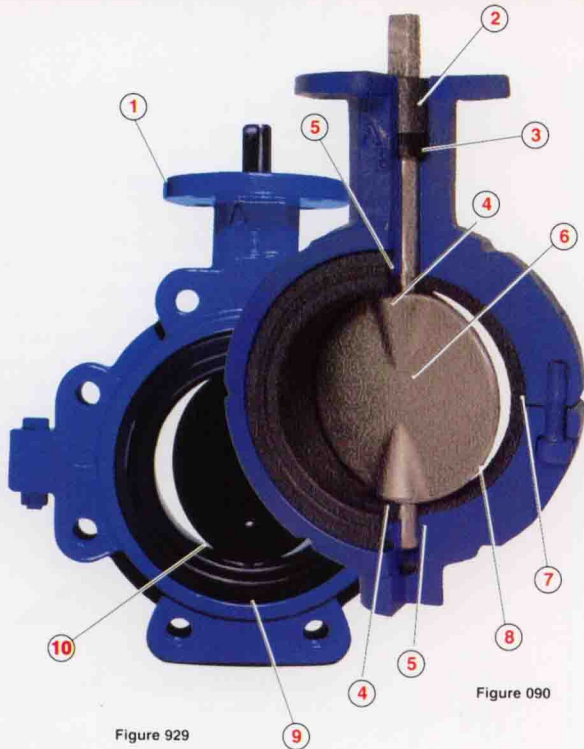

Figure 929

Figure 090

Various materials are available for a wide selection of applications. The figures 090/929 provide excellent flow characteristics with the thin profile of their one-piece disc/stem. These valves fit a variety of applications in the chemical and food industries which may require chemical resistance or sanitary features.

- 1 Bodies are machined to high tolerances. Guaranteed standard dimensions for interchangeability of parts and actuators.
- 2 Top bushing is impact and corrosion resistant material. Protects the stem from side thrust of actuators.

- 3 Special double V-shape of stem seal self-adjusts to protect the stem area for either vacuum or pressure use.

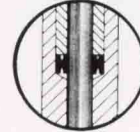

- 4 Stem and body are isolated from line media by the seal created between the arch surface of the disc (described by the radius of the disc), and the flat surface of the seat.

- 5 The special snap-in Resil-O-Seat™ design fixes seat in place without bonding. The Resil-O-Seat™ is 100% field replaceable — no special tools required. Resil-O-Seat™ available in a variety of materials.

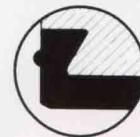

- 6 Specially designed disc/stem prevents distortion of disc under high pressure. Thin disc allows for maximum open flow.

- 7 Two-piece body of figures 090/929 and one-piece disc/stem makes field replacement of seat and disc/stem quick and easy.

- 8 Disc edge is individually processed through machining for a smooth edge, providing a bubble tight shut-off and maximum seat life.

- 9 Molded O-ring in the Resil-O-Seat™ forms a seal against all standard ANSI flanges. Gasketing requirements are eliminated.

- 10 Elastomer covered 17-4 stainless steel disc/stem is for use when abrasive or chemical resistance is required. The encapsulated one-piece disc/stem is isolated from the stream.



Pneumatic actuator/limitswitch



Pneumatic actuator/positioner



Electric worm gear drive actuator

Notes:

1. Valves rated from 100 to 150 psi, determined by disc/stem and seat material.
2. Available in sizes 2" through 12".
3. Sizes 2.5" and 5" are not available with elastomer covered discs.

ABZ BUTTERFLY VALVES FIGURES 101/102/108

Resil-O-Seat™

For General Purpose Industrial
Applications, Heating, Ventilation
and Air Conditioning Systems

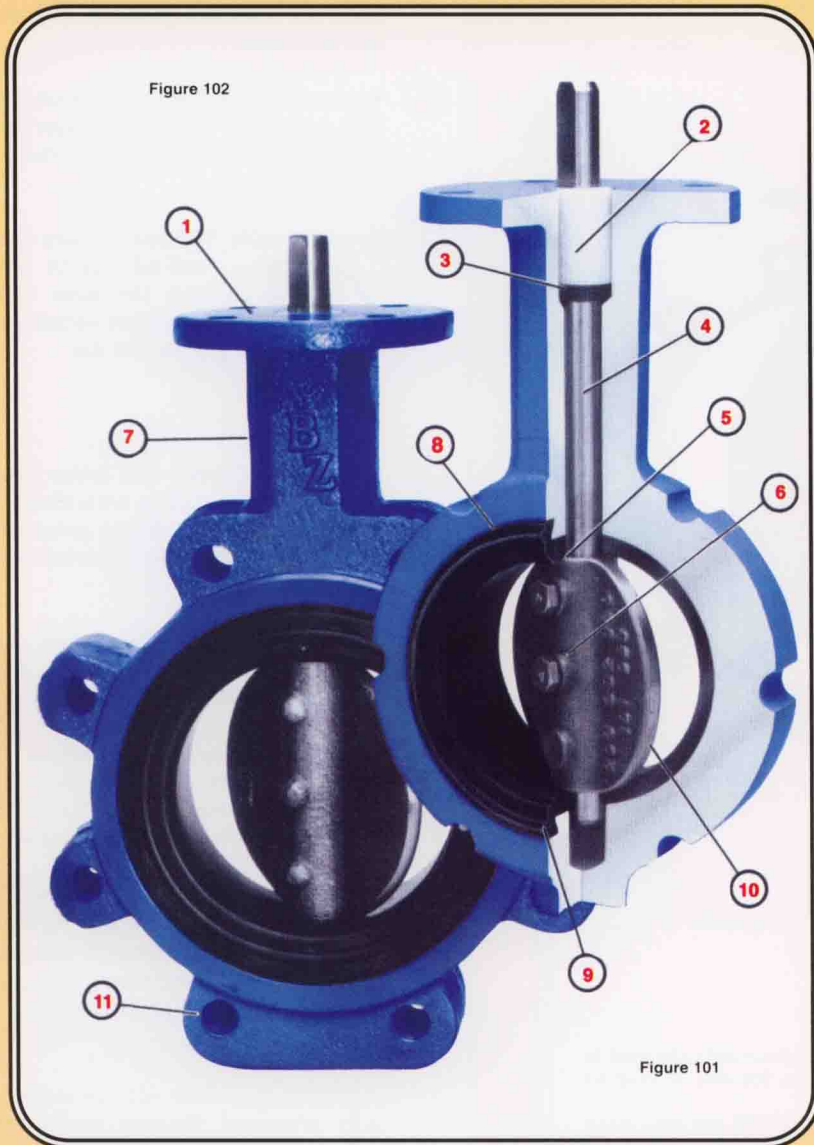

Figure 101



Fig. 101 - wafer



Fig. 102 - lug

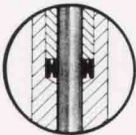
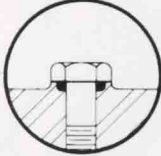
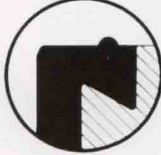

Fig. 108 - semi lug

- ① All cast body machined to high tolerances. Guaranteed standard dimensions for interchangeability of parts and actuators.
- ② Top bushing is impact and corrosion resistant material. Protects the stem from side thrust of actuators.
- ③ Special double V-shape of stem seal self-adjusts to protect the stem area for either vacuum or pressure use.
 
- ④ Stem extends through disc and aligns with socket in body. Stem end has standard dimensions for operator interchangeability.
- ⑤ Stem and body are isolated from line media by seal created between disc flats and flat surface of seat.
- ⑥ Stainless steel cap screws securely hold disc to stem. O-ring seal prevents leakage into the stem area and creates a shake-proof connection.
 
- ⑦ Long neck allows for insulation requirements.
- ⑧ The special snap-in Resil-O-Seat™ design fixes seat in place without bonding. The Resil-O-Seat™ is 100% field replaceable. No special tools are required.
 
- ⑨ Molded O-ring in the Resil-O-Seat™ forms a seal against all standard ANSI flanges. Gasketing requirements are eliminated.
- ⑩ Disc edge is individually processed through machining and hand buffing for a smooth edge, providing a bubble tight shutoff and maximum seat life. All valves tested to 200 PSI.
- ⑪ Figure 102 has drilled and tapped lugs for 125/150 pound ANSI drilling and can be used for applications where a full lug body is required.

Notes:

1. Valves rated for 175 PSI.
2. Available in sizes 2" through 12".

ABZ BUTTERFLY VALVES

FIGURES 201/202

Resil-O-Seat™ Butterfly Valves for Industrial, Chemical, and Food & Beverage Applications

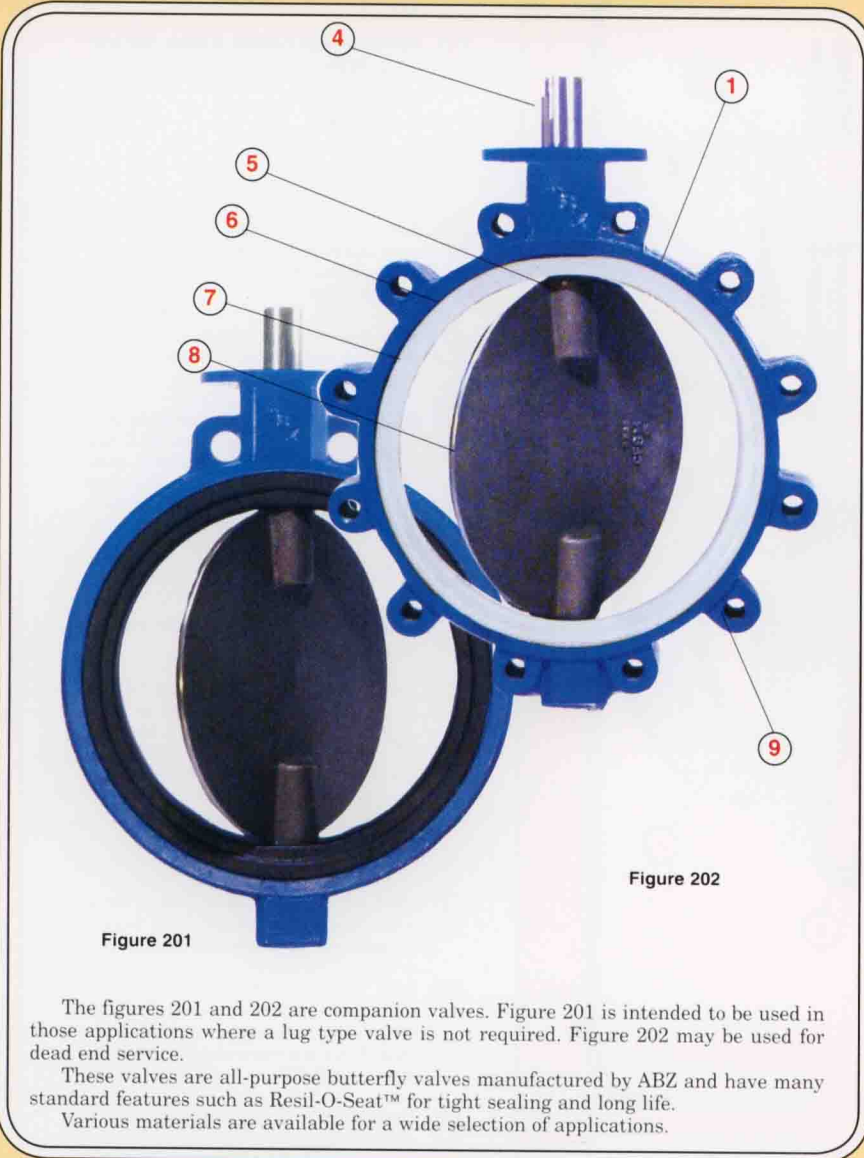

1 All cast body machined to high tolerance. Guaranteed standard dimensions for interchangeability of parts and actuators.

2 Top and bottom bushings are impact and corrosion resistant materials. Protects the stem from side thrust of actuators.

3 Special double V-shape of stem seal self-adjusts to protect the stem area for either vacuum or pressure use.

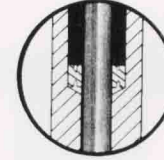

4 Valve has an upper and lower stem giving an internal drive with tremendous strength. This design gives you a thin profile disc for superior flow characteristics.

5 Stem and body are isolated from line media by seal created between disc flats and flat surface of seat.

6 The special snap-in Resil-O-Seat™ design fixes seat in place without bonding. The Resil-O-Seat™ is 100% field replaceable – no tools required.

7 Molded O-ring in the Resil-O-Seat™ forms a seal against all standard flanges. Gasketing requirements are eliminated.

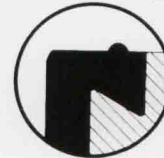

8 Disc edge is individually processed through machining and hand buffing for a smooth edge, providing a bubble tight shutoff and maximum seat life.

9 Figure 202 has drilled and tapped lugs for 125/150 pounds ANSI drilling and can be used for applications where a full body lug is required.



NOTES:

1. Valve is rated to 150 PSI.
2. Available in 14" to 20".

ABZ BUTTERFLY VALVES

FIGURES 396/397

For Industrial, HVAC, Oil Patch,
and Agricultural Services

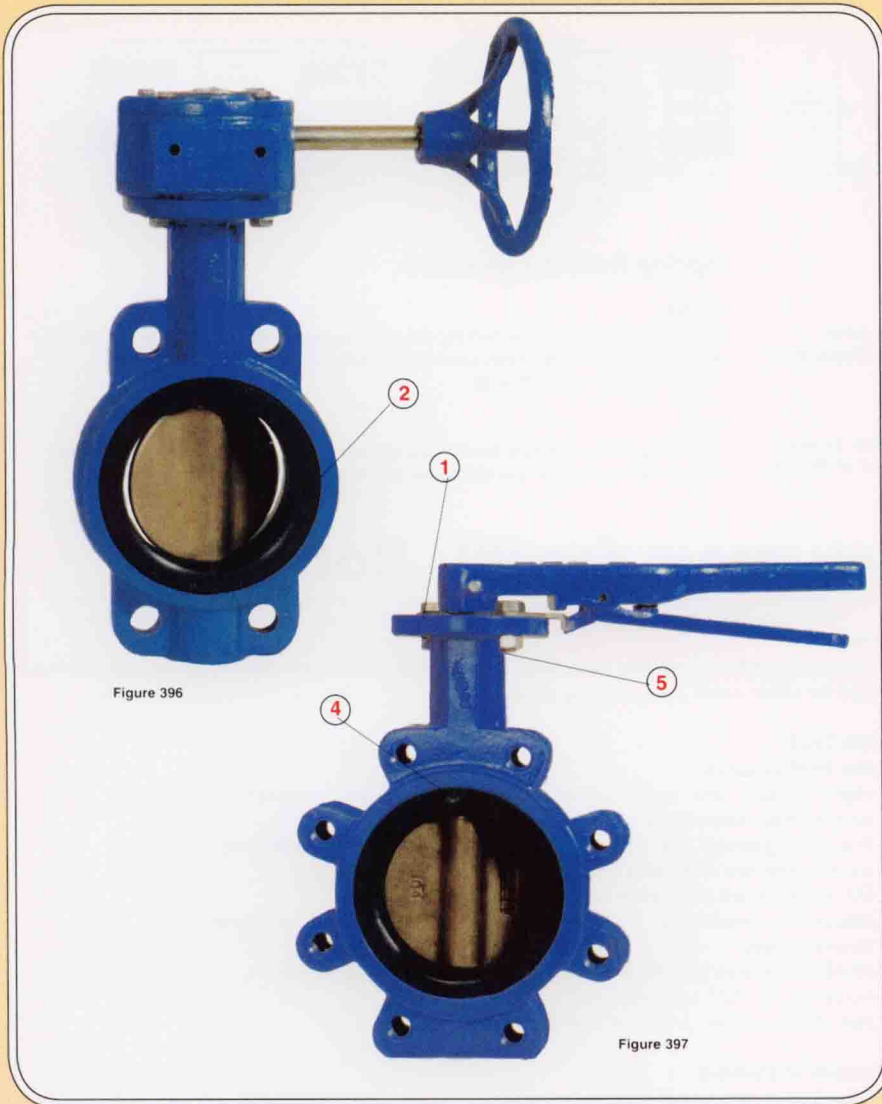

Figure 396

Figure 397

1. This valve, like the entire ABZ line, is completely universal on the top-side dimension and face to face.

2. The molded-in seat is non-collapsible, stretch resistant and blowout proof in 2" through 24".

3. ABZ's stem to disc engagement is internally driven. This gives you a positive engagement with no external pins that could vibrate loose.

4. The figure 396/397 has a series of molded in o-rings that give extra protection around the stem area. This helps prevent the possibility of stem leakage.

5. The figure 396/397 utilizes Graphite-Teflon impregnated bushings giving you a wear resistant self lubricating material that won't seize like bronze bushings.

6. The 2"-12" valves rated to 200 PSI close off, and 200 PSI dead end service. The 14"-24" valves rated to 150 PSI close off and 150 PSI dead end service. The 396/397 is suitable for vacuum service.

The ABZ figure 396/397 is designed for complete adaptability to utilize various actuators for throttling. They may be used with handles, gear operators, pneumatic or electric operators. As requirements change or demand arises, actuators can be changed without changing the valve.

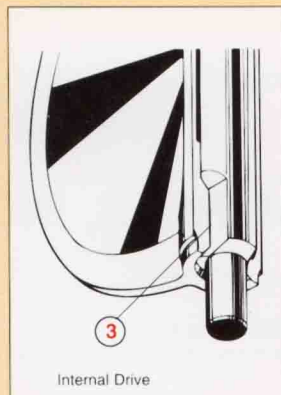

Notes:

1. 2" - 12" Valves rated to 200 PSI.
2. 14" & Larger rated to 150 PSI.

General Technical Data



Operation

- Standard Working Temperature – 20°F to 175°F
- Maximum Working Pressure 150 psi
- Operating Media – Clean, Dry Air, Non-Corrosive Gas or Light Hydraulic Oil
- Air Supply 40 psi – 150 psi
- Rotation 90°
- Travel Stops Standard
- Permanently Lubricated Units

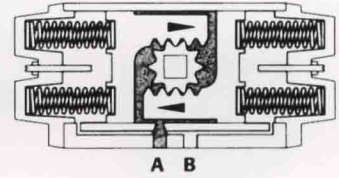
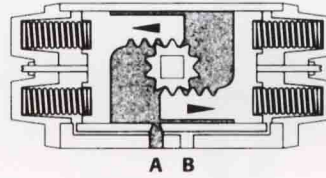
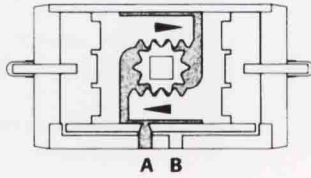
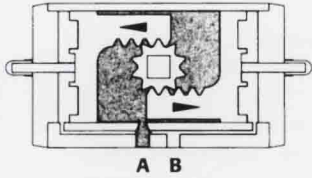

Double Acting Operation

CCW

Air is supplied to Port A forcing the pistons away from each other (toward ends), rotating drive pinion counterclockwise and exhausting air out of Port B.

CW

Air is supplied to Port B forcing the pistons toward each other (toward center), rotating drive pinion clockwise and exhausting air out of Port A.

Spring Return Operation

CCW

Air is supplied to Port A forcing the pistons away from each other (toward ends), rotating drive pinion counterclockwise, compressing springs and exhausting air out of Port B.

CW

Air is supplied to Port B forcing the pistons toward each other (toward center), rotating drive pinion clockwise and exhausting air out of Port A.

ABZ Electric Actuators for 90° Rotation

APPLICATION

ABZ Actuators are designed for automating most types of quarter turn valves; are well suited for nearly all industries; and are ideal for either on/off or modulating service.

CHARACTERISTICS

■ Reliable Performance

- Highly reliable and easily adjustable limit switches are provided along with a torque switch assembly as standard equipment.
- Precision gearing and use of ball bearings maximizes efficiency of power transfer with low noise level (Max. 50dB).
- Self locking at any position by means of wormgears.
- Adjustable mechanical stops give high safety factors at both ends of actuator travel.
- All ABZ Actuators have Hand/Auto declutching handwheel overrides.
- Actuators are "CE" approved.
- Approved explosion proof per 'Exd IIB T4 IP67'.

■ Availability of Options

- Choice of various power supplies by conversion of electrical module.
- Position transmitter.
- Additional auxiliary limit switches.
- Local/Off/Remote selector switch and Local control switches (Open/Stop/Close).
- 90° to 270° rotation
- Explosion proof with watertight enclosure (Exd IIB T4 IP67).
- Proportional control unit.
- Failsafe rechargeable battery pack.



ABZ VALVES & CONTROLS, INC.

Haleson 
Sanitary / Biopharma / Industrial
www.halesoninc.com