

PRODUCT OVERVIEW



About FLUX

FLUX pump technology – the right solution even for demanding fluids



One Brand. One Promise.

The FLUX name has been synonymous with pump technology for more than 60 years. It was the invention of the electric drum pump that sparked it all off. In the meantime of course the technology has become more sophisticated. FLUX company innovations have markedly improved working routines for filling and transferring fluids.

It is often said that medium-sized companies are the engines of progress. We would be pleased if our family business were able to substantiate this claim.

When you choose FLUX you are making a good decision for the long term. With our products we want to assist you to save time and money and by the way – spare your nerves as well. We are therefore delighted when you discuss your requirements with us.

Best wishes,

Klaus Hahn,
CEO FLUX-GERÄTE GMBH

Pumping, emptying, mixing, filling and metering – when liquids are set in motion the requirements are very diverse. In any event the process must run smoothly. This is what the FLUX brand name stands for. It is recognised across the globe as a byword for quality, for safety and for solutions which are able to fulfil every single demand on a long-term basis.

Smooth-running processes – FLUX not only guarantees this for liquids which are relatively easy to pump but also when the pumping medium is viscous or doesn't flow at all, when it is aggressive or used in processes which are common in the hygiene sector or sectors where there is an explosion hazard. To ensure that the tasks are solved in the best possible way for the customer FLUX has a huge range of expertise to offer. In other words, a lot more than just pumps. From a technical point of view this means a comprehensive product system of pumps, motors, flow meters, accessories and a whole lot more. From the project point of view, "More than just pumps", means accompanying our customers from the first telephone call through to the end solution – and if required beyond that.

This is how FLUX keeps processes moving. Long-term. Simple, complex or custom-made inclusive design assignments: FLUX is prepared for any request and in particular for the fact that our customers need more than just pumps.

MILESTONES OF PUMP TECHNOLOGY:

1950

First electric drum pump worldwide

1953

First explosion protected drum pump

2003

First brushless drum pump motor

1951

Foundation of the FLUX-GERÄTE GmbH

1997

First commutator motor according to ATEX directive





Quality

From the inventors of the electric drum pump.

- ▶ **Reliability.** In concrete terms: Every minute of downtime is a minute too much. FLUX strives to prevent downtimes in the best way possible.
- ▶ **Long service life.** High-quality technology is one of the most important prerequisites for long-term trouble-free processes.
- ▶ **Made in Germany.** FLUX has its central production location in Maulbronn, Baden-Württemberg.
- ▶ **Awards.** Such as the iF Product Design award which FLUX brand products have won several times underline the unique claim of the FLUX brand.



Customer focus

Individual solutions for your requirements.

- ▶ **Extensive range of products.** FLUX offers an extensive range of products based on individual components, pre-configured sets and system solutions.
- ▶ **Individual solutions.** For specific requirements FLUX designs and implements special adaptations, custom-made products and complex solutions in-house.
- ▶ **Technology partners.** FLUX consultants are the competent contact for the customer – on the telephone or with the customer on site.
- ▶ **On-call delivery.** All popular products are available from the large warehouse at the headquarters in Maulbronn. Local warehouses in different countries supplement capacities where it is economical to do so.
- ▶ **After-sales support.** FLUX guarantees a repair service and supply of replacement parts for a period of up to 20 years following date of purchase.



Safety

Good to know: It's a FLUX product.

- ▶ **Demanding media.** FLUX technology covers an enormous spectrum of differing media. It goes without saying that FLUX provides maximum safety and reliability for demanding media as well.
- ▶ **Special solutions for individual industries.** Different industries. Different challenges. Whether food industry, pharmaceuticals industry, hygienic or explosion-hazard sectors: The focus always is on product and user safety.
- ▶ **Handling.** Risks which could otherwise occur in operation have already been taken into consideration by FLUX in the design phase. The result: Products which are able to handle complex tasks but which can still be operated with a few simple movements.

2014

First brushless battery motor to drive pumps worldwide

2022

Progressive cavity pumps VISCOPOWER

2010

Further development of the VISCOFLUX drum emptying systems

2017

Magnetically Centrifugal Pumps MAGSON



Industries, Certificates and Conformities

The right solution for every industry

With its application-based products FLUX has the right solution for every sector of industry. Use our icons as a guide to help you to find the products which are suitable for your industry.



Chemical



Industry



Surface technology



Paints and lacquers



Petrochemicals



Foods



Cosmetics



Pharmaceuticals



Water treatment











Agriculture

Certified safety for the most widest range of industries and countries: FLUX products have been developed and certified for use around the world; they comply with the highest demands and safety standards. With FLUX you are always on the safe side everywhere.

All FLUX products conform to pertinent fundamental health & safety regulations of the EC Machinery Directive 2006/42/EC and are therefore CE certified. In addition, FLUX products bear the Eurasian EAC mark issued by the customs union of Russia/Belarus/Kazakhstan.



Furthermore, selected FLUX products are available with the following certificates:

<p>For use in the pharmaceutical, foods and cosmetics sector there are pumps with 3A certification, FLUX FOOD pumps conform to EG 1935/2004 and are suitable for contact with food or products available which conform to FDA CFR 21.</p>	  
<p>Dependent on version FLUX motors are available with VDE GS, UL or also CSA test certification are available.</p>	   
<p>For use in explosion-hazardous areas FLUX products with explosion protection are available which are built and certified to conform to ATEX Directive 2014/34/EU.</p>	

Mobile pumps

Summary of FLUX pump series	06
Drum and container pumps (series 300/400)	08
JUNIORFLUX/COMBIFLUX (series 300)	09
Drum and container pumps (series 400)	10
Progressive cavity pumps (series 500)	12
Suitable motors for FLUX pumps series 300, 400 and 500	14
Flow meters (FMC/FMO/FMT)	16

Process pumps

Magnetically centrifugal pumps and submersible pumps (MAGSON)	18
Centrifugal immersion pumps (series 600/700)	22
Air-operated diaphragm pumps (series FDM/RFM)	24

System solutions

Filling systems	26
Drum emptying systems – VISCOFLUX family	28
Customized all-in solutions	29







Mixers	30
---------------	-----------

Filters and Filter housings SONCO	31
--	-----------

Additional products and accessories	34
--	-----------

Summary of FLUX pump series

Helps you to identify the best pump for your requirements quickly

	Mobile pumps	Mobile pumps	Mobile pumps	Systems	
FLUX Pump Series	Drum pumps series 300 JUNIORFLUX/ COMBIFLUX	Drum and container pumps series 400	Eccentric worm-drive pumps series 500	Drum emptying systems VISCOFLUX	
					
	Page 9	Page 10-11	Page 12-13	Page 28	
Typical areas of application	Mobile filling of liquid media in small quantities	Mobile filling of liquid media (incl. pre-defined quantities) and/or mixing	Mobile and stationary filling of low through high viscosity media incl. shear-sensitive media (incl. pre-defined quantities)	Mobile and stationary filling of high-viscosity media and media just capable of flowing through to media not capable of flowing (incl. pre-defined quantities)	
Container/ application	Small containers, ~ 200-l-drums ~ 1,000-l-IBCs	~ 200-l-drums ~ 1,000-l-IBCs tanks > 1,000 l	~ 200-l-drums ~ 1,000-l-IBCs tanks > 1,000 l as process pump	~ 200-l-drums with Ø 560 mm, 571 mm conical drums	
Flow rate max.*	60 l/min	240 l/min	80 l/min	Max. 50 l/min depending on viscosity and flow properties	
Head max.*	8.5 mwc	30 mwc	80 mwc	80 mwc	
Viscosity max.*	250 mPas	1,200 mPas	100,000 mPas	Pasty	
Available certificates					
Special features	<ul style="list-style-type: none"> ▶ Brushless battery motor 	<ul style="list-style-type: none"> ▶ Mixing pump ▶ 99.98 % drum emptying ▶ Easily stripped down pump ▶ Also as application-based pump sets 	<ul style="list-style-type: none"> ▶ Pump can be dismantled very quickly ▶ Non-contact flow measurement possible ▶ Also available as application-specific pump sets 	<ul style="list-style-type: none"> ▶ Also for conical drums ▶ Also for seaworthy container drums ▶ Flow metering via bearing flange with pulse generator where required ▶ Integration in processes via control unit possible 	
Drive options	Electric Optional mains connection or storage battery	Electric or pneumatic	Electric or pneumatic	Electric or pneumatic	

* The maximum flow rate is a test bench value, measured with water at 20 °C at the pressure port of the pump, without accessories (hose, nozzle, flow meter)

	Process pumps	Process pumps	Process pumps	Process pumps
	Magnetically centrifugal pumps	Submersible pumps	Centrifugal immersion pumps series 600 and 700	Air-operated diaphragm pumps series FDM and RFM
				
	Page 18–20	Page 21	Page 22	Page 24
	Process pumps made of solid plastic for the chemical industry, electroplating etc. for pumping aggressive media	Submersible motor pumps for pumping and circulation of chemically aggressive media from sumps, tanks or similar	Stationary and mobile usable process pumps for filling and circulating liquid media in bulk quantities	Process pumps for liquid (incl. abrasive) to high-viscosity media – for low to high flow volumes and high pressure build-up
	as process pump	tanks > 1,000 l as process pump	~ 1,000-IBCs tanks > 1,000 l as process pump	~ 1,000-IBCs tanks > 1,000 l as process pump
	2,000 l/min	330 l/min	74 m ³ /h	1,000 l/min
	44 mwc	12 mwc	35 mwc	200 mwc
	250 mPas	250 mPas	2,500 mPas	15,000 mPas
				
	<ul style="list-style-type: none"> ▶ Modular system ▶ Sturdy housing ▶ Different connection types ▶ Magnetic coupling, therefore hermetically sealed ▶ Process pumps 	<ul style="list-style-type: none"> ▶ Motor IP68 ▶ Magnetic coupling, therefore hermetically sealed ▶ Mobile use 	<ul style="list-style-type: none"> ▶ E.g. can be used for AdBlue[®] tank systems 	<ul style="list-style-type: none"> ▶ Stroke counter can be integrated ▶ Filter press high-pressure pump ▶ Cycle control can be integrated ▶ Version with flap valve for semi-solids of max. 50 mm
	Electric	Electric	Electric	Pneumatic

** AdBlue[®] is a registered trademark of: Verband der Automobilindustrie e. V. (VDA)

Drum and container pumps

For pumping low viscosity fluids out of various containers



FLUX drum and container pumps are suitable for pumping various low-viscosity and also especially aggressive and highly-flammable fluids. The axial-impeller pumps provide a pulsation-free pumping action. Constructed on the modular design, different pumps are able to be driven by the same motor. As a result of their low weight the pumps can be easily carried from container to container. The easy handling of motor and pump keeps changeover times short.

Various pumps with and without mechanical seal are available as well as versions for higher pumping heads and mixing pumps. FLUX drum and container pumps are available in versions with explosion protection, with 3A certification as well as FLUX FOOD pumps (Directive (EC) 1935/2004 and FDA CFR 21 compliant). Moreover especially pre-configured pump sets for typical applications are available.

Technical data



	Series 300	Series 400
For container	Small containers, ~200-l-drums, IBCs	Small containers, ~200-l-drums, IBCs tanks > 1,000 l
Flow rate max.	60 l/min*	240 l/min*
Head max.	8.5 mwc*	30 mwc*
Viscosity max.	250 mPas*	1,200 mPas*
Motor drive	Electric	Electric/pneumatic



Battery motor FBM-B 3100 – the solution where cables are problematic or not desired.

Ancillary products and accessories

A wide range of ancillary products and accessories is available for many different FLUX drum and container pump applications such as e. g.

- ▶ Fume gland
- ▶ Flow meters
- ▶ Hoses
- ▶ Filling units
- ▶ Hand nozzles and other outlet fittings



FLUX FOOD – for application in the food industry.

* The maximum flow rate is a test bench value, measured with water at 20 °C at the pressure port of the pump, without accessories (hose, nozzle, flow meter)

JUNIORFLUX/COMBIFLUX

For filling small quantities



The small drum pumps JUNIORFLUX and COMBIFLUX are particularly suitable for filling comparatively small quantities from containers such as cans up to 200 litre drums. The small diameter of the outer tube makes it possible to pump out of tight openings.

JUNIORFLUX

For filling small quantities; with fixed commutator motor

Advantages/characteristics:

- ▶ Motor and pump with fixed connection
- ▶ Available with choice of two types of seal
- ▶ Low overall weight – minimal amount of exertion necessary when changing drums
- ▶ Can pump out of narrow-necked containers

Examples of media:

- ▶ Acids and lyes
- ▶ Fertiliser solutions
- ▶ Pesticides
- ▶ Cleaning agents
- ▶ Demineralized Water (purified water)

Technical data	
Flow rate max.	57 l/min*
Head max.	8.5 mwc*
Viscosity max.	250 mPas*
Pump material Outer tube	Polypropylene, Polyvinylidene fluoride, Stainless steel
Immersion length (mm) (standard)	500/700/1,000

COMBIFLUX

For filling small quantities; with removable motor

Advantages/characteristics:

- ▶ Motor easy to remove
- ▶ Connection of motor to pump via quick-action coupling
- ▶ Driven by a brushless battery motor or electrical commutator motor with mains connection
- ▶ Sealless design
- ▶ Low overall weight minimal – amount of exertion necessary when changing drums

Examples of media:

- ▶ Acids and lyes
- ▶ Fertiliser solutions
- ▶ Pesticides
- ▶ Cleaning agents
- ▶ Demineralized Water (purified water)

Technical data	
Flow rate max.	60 l/min*
Head max.	8.5 mwc*
Viscosity max.	250 mPas*
Pump material Outer tube	Polypropylene, Polyvinylidene fluoride, Stainless steel
Immersion length (mm) (standard)	500/700/1,000/ 1,200

* The maximum flow rate is a test bench value, measured with water at 20 °C at the pressure port of the pump, without accessories (hose, nozzle, flow meter)

Drum and container pumps

For pumping low viscosity fluids out of various containers

FLUX drum and container pumps are always a "double act" comprising motor and pump. Both components can vary quite flexible. For example different pumps are able to be driven with the same motor. Ideal for reliable pumping of various low-viscosity liquids – incl. especially aggressive and highly flammable ones. As a result of their low weight the pumps can be easily carried from container to container. The easy handling of motor and pump keeps changeover times short.

F 430/FP 430 With mechanical seal



Advantages/characteristics:

- ▶ No carrying-over of the medium – one pump can be used for different media
- ▶ Easily dismantled for fast cleaning
- ▶ Immersion depth to 3,000 mm possible
- ▶ FOOD version available
- ▶ Stainless steel and Hastelloy C versions can be used in hazardous areas
- ▶ Available as version for dry running installation
- ▶ Steel core in the inner tube (PP and PVDF) provides greatest stability and prevents longitudinal changes at high and low temperatures

Examples of media:

- ▶ Suitable for almost all low-viscosity fluids incl. FOOD media

F 424/FP 424 Sealless design



Advantages/characteristics:

- ▶ Low-maintenance – due to sealless design
- ▶ Built to last
- ▶ Stainless steel version for use in hazardous areas
- ▶ Non-sensitive to dry running
- ▶ No contamination from lubricants or wear of seal materials possible

Examples of media:

- ▶ Suitable for almost all low-viscosity media



Technical data	F 430/FP 430	F 424/FP 424	F 427/FP 427	F 425/FP 425	F 426
Flow rate max.	240 l/min*	240 l/min*	240 l/min*	130 l/min*	240 l/min*
Head max.	30 mwc*	30 mwc*	13 mwc*	13 mwc*	13 mwc*
Viscosity max.	1,200 mPas*	1,200 mPas*	1,000 mPas*	1,200 mPas*	1,200 mPas*
Pump material Outer tube	Polypropylene, Polyvinylidene fluoride, Stainless steel, Aluminium, Hastelloy C	Polypropylene, Polyvinylidene fluoride, Stainless steel	Stainless steel	Polypropylene, Stainless steel, Hastelloy C	Polypropylene, Stainless steel
Immersion length (mm)(standard)	700/1,000/1,200	700/1,000/1,200	700/1,000/1,200	700/1,000/1,200	1,000/1,200

* The maximum flow rate is a test bench value, measured with water at 20 °C at the pressure port of the pump, without accessories (hose, nozzle, flow meter)

F 427/FP 427

Can be taken apart completely



Advantages/characteristics:

- ▶ Easy and fast disassembly for cleaning or sterilisation
- ▶ Can be completely stripped down to individual parts without using tools
- ▶ Minimal dead spots
- ▶ Also available as FOOD and 3A certified version

Examples of media:

- ▶ Suitable for almost all applications; also for products in the pharmaceutical, FOOD and cosmetics industries

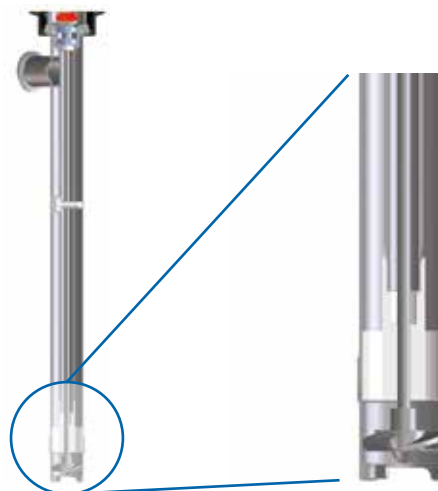

F 425/FP 425

For 99.98 % drum emptying



Advantages/characteristics:

- ▶ Less than 0.05 l residual amount left in 200-l-drum
- ▶ Flowback stop valve prevents back flow of the medium into the emptied drum
- ▶ With optimal use of the product reduced drum cleaning or waste disposal costs
- ▶ Stainless steel version can be used in hazardous areas
- ▶ Highest stability provided by steel core in inner tube; no longitudinal changes at high and low temperatures

Examples of media:

- ▶ Valuable, high-quality liquids e. g. cosmetics additives
- ▶ Toxic, dangerous and environmentally damaging substances

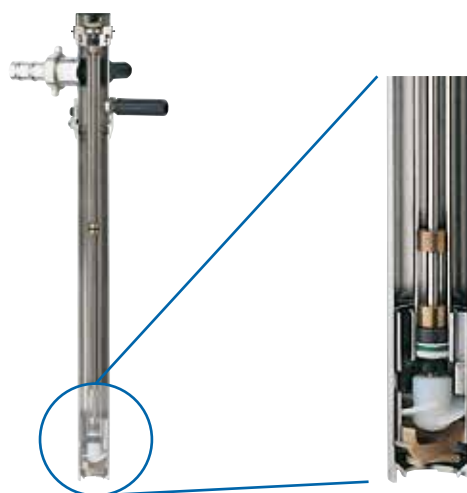

F 426

For mixing and/or pumping



Advantages/characteristics:

- ▶ For pumping and/or mixing inhomogeneous media
- ▶ Switch lever for easy changing between mixing/pumping and pumping – during running operation, too
- ▶ Easily disassembled for fast cleaning
- ▶ Stainless steel version can be used in hazardous areas
- ▶ Steel core in the inner tube prevents longitudinal changes at high or low temperatures

Examples of media:

- ▶ Paints, lacquers, 2-phase mixtures, emulsions

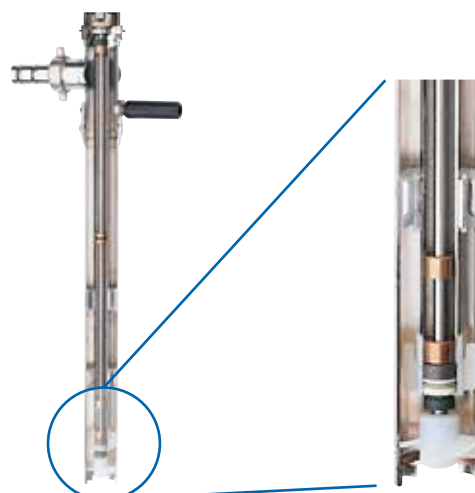

Progressive cavity pumps VISCOPOWER

For pumping low to high-viscosity media



FLUX VISCOPOWER progressive cavity pumps are suitable for pumping thin to high-viscosity fluids. The positive displacement pumps work low turbulence, at constant pressure and ensure gentle, pulsation-free pumping. The VISCOPOWER progressive cavity pumps can be used in the industrial sector as well as for the pharmaceutical, food and cosmetics (hygiene) sectors. All VISCOPOWER progressive cavity pumps can be used in mobile and stationary applications, consist of only a few components and are easy to dismantle.

Our progressing cavity pumps are available for operating directly in the medium or outside the container, versions with explosion protection, 3-A certification and FLUX FOOD pumps (compliant with Regulation (EC) 1935/2004 and FDA CFR 21). For the motor connection, you can choose between bearing flange and gearbox. Our VISCOFLUX drum emptying systems with progressive cavity pumps are available for pumping particularly viscous and highly viscous media (see page 28).

Technical data



Motor connection	Gear F 570	Flange F 580
Container/application	~ 200-l-drums, ~ 1,000-l-IBC, tanks > 1,000 l	
Flow rate max.	80 l/min*	
Head max.	80 mwc*	
Viscosity max.	80,000 mPas	100,000 mPas
Motor drive types	Electric, pneumatical	

Advantages/characteristics:

- ▶ High delivery pressure up to 15 bar due to positive displacement principle
- ▶ High delivery rate of up to 80 l/min
- ▶ Very easy and quick cleaning
- ▶ Wide viscosity range can be covered
- ▶ Ideal for the pharmaceutical and food sectors due to low dead space design
- ▶ Can be used vertically and horizontally
- ▶ Also with 3A certificate
- ▶ Also available as explosion-proof pumps



VISCOPOWER 570 in food applications.



VISCOPOWER 570 in industrial applications.

* The maximum flow rate is a test bench value, measured with water at 20 °C at the pressure port of the pump, without accessories (hose, nozzle, flow meter)

Progressive cavity pumps

VISCOPOWER F 570 with gear



- ▶ Positive displacement pump
- ▶ Gear ratio two-stage 1:16 or single-stage 1:7
- ▶ Low-turbulence and gentle pumping
- ▶ Low pulsation in relation to the flow
- ▶ Comprehensive modular system
- ▶ Also available with variable speed setting (delivery proportional to speed)
- ▶ Pump/shaft/rotor can be dismantled
- ▶ For use with air motors, commutator motors or brushless motors
- ▶ Lightweight – for mobile use
- ▶ 100% made in Germany
- ▶ Available with 3A certification
- ▶ Explosion-protection version available
- ▶ Available as FLUX FOOD pump



Progressive cavity pumps

VISCOPOWER F 580 with bearing flange



- ▶ For use with asynchronous motors, spur gear motors or compressed air motors
- ▶ For low-viscosity to highly viscous, paste-like media up to 100,000 mPas
- ▶ Robust
- ▶ For stationary use
- ▶ In combination with VISCOFLUX mobile S also suitable for media that are no longer flowable media
- ▶ Available with speed sensor for indirect, non-contact flow measurement
- ▶ 100% made in Germany
- ▶ Available with 3A certification
- ▶ With Ex certification if required
- ▶ Available as FLUX FOOD pump



Progressive cavity pumps

VISCOPOWER F 580 for dry installation



- ▶ For containers that are not accessible from above
- ▶ Positive displacement pump
- ▶ Low-turbulence and gentle pumping
- ▶ Low pulsation in relation to the flow
- ▶ Comprehensive modular system
- ▶ Also available with variable speed setting (delivery proportional to speed)
- ▶ Pump/shaft/rotor can be dismantled
- ▶ Driven by three-phase AC, gear or FPM air motors
- ▶ Pump is installed dry, i. e. not in the medium
- ▶ Various stator materials: NBR white, FKM, PTFE, EPDM
- ▶ 100% made in Germany
- ▶ Available with 3A certification
- ▶ With Ex certification if required
- ▶ Available as FLUX FOOD pump

















Suitable motors

For the FLUX pumps of the series 300, 400 and 500

Pump series/-type	300			400 and VISCOPOWER		
Suitable motors Type	Battery (brushless)	Commutator				
Motor type	FBM-B 3100	FEM 3070	FEM 4070	F 457	F 458	F 460 Ex
Image						
Protection class	IP 44	IP 24	IP 24	IP 24	IP 55	IP 55
Ex-marking	-	-	-	-	-	Yes
Certificates						
Venting	External	Internal	Internal	Internal	External	External
Voltage (volts) Frequency	110-120/ 220-240 V 50-60 Hz	100/110/120/230/240 V 50-60 Hz		110/120/ 230/240 V 50-60 Hz	12/24/110/120/230/240 V 50-60 Hz	
Power (watts)	100	230	500	800	460/700	460/700
Speed setting	Variable	2 steps	Stepless	Optional	Optional	Optional
Weight (kg)	1.2	1.5	2.6	4	5.1/5.9	5.1/5.9
Low voltage protection	-	-	Optional	Optional	Optional	Optional
Advantages/ characteristics	<ul style="list-style-type: none"> ▶ Brushless battery motor ▶ No mains connection required ▶ Can be utilised immediately at will ▶ Long battery runtime up to 120 min ▶ Maintenance-free ▶ Battery charged within 30 min ▶ Li-Ion battery ▶ Awarded with Red Dot Design Award 	<ul style="list-style-type: none"> ▶ Commutator motor ▶ With mains connection ▶ Also for filling small quantities ▶ Low overall weight ▶ Connection between motor and pump via quick-action coupling 	<ul style="list-style-type: none"> ▶ Commutator motor ▶ Low noise level ▶ With infinitely variable rpm adjustment ▶ Compact construction ▶ Low weight ▶ Awarded with Red Dot Design Award 	<ul style="list-style-type: none"> ▶ Commutator motor ▶ Most powerful drum pump motor ▶ Low noise level ▶ F 457 EL: with infinitely variable rpm adjustment 	<ul style="list-style-type: none"> ▶ Commutator motor ▶ Extremely tough housing in aluminium ▶ With acid-proof finish ▶ Extremely low noise ▶ Motor is completely encapsulated ▶ F 458: 460 watts ▶ F 458-1: 700 watts ▶ F 458 EL: with infinitely variable rpm adjustment 	<ul style="list-style-type: none"> ▶ Commutator motor ▶ Extremely tough housing in aluminium ▶ Motor is completely encapsulated ▶ F 460 Ex: 460 watts ▶ F 460-1 Ex: 700 watts ▶ F 460 Ex EL: 460 watts with infinitely variable rpm adjustment



constructed according to ATEX Directive 2014/34/EU, Category 2

				VISCOPOWER			
Brushless	Three-phase	Compressed air		Three-phase			
FBM 4000 Ex	F 414	F 416 Ex	FPM	DSM	Spur gear	F 403	
							
IP 55	IP 55		IP 55	IP 55	IP 54	IP 55	
Yes	-	Yes	Yes	Yes	-	Yes	
							
External	External	Compressed air	Compressed air	External	External	External	
230 V 50-60 Hz	230/400 V 50 Hz	6 bar air pressure		230/400 V 50 Hz	380-500 V 100 Hz	230/400 V 50 Hz	
600	550/750/1,100	470	600-2,000	800-1,100	55-550	550	
Stepless	-	Optional	Via air volume	-	Stepless	-	
6.2	8.8-12.8	0.9-1.4	5-10	12.5-23	11.9	8	
Yes	-	-	-	-	-	-	
<ul style="list-style-type: none"> ▶ Brushless motor ▶ Extremely low wearing ▶ Maintenance-free ▶ Low life-cycle costs ▶ With infinitely variable rpm adjustment ▶ Especially low noise ▶ Extremely tough housing with double skin in aluminium 	<ul style="list-style-type: none"> ▶ Three-phase gear motor ▶ Increased running period possible ▶ Available with motor protection switch or terminal box ▶ Constant rpm 	<ul style="list-style-type: none"> ▶ Compressed air motor ▶ Extremely light and easy to handle ▶ Extremely powerful ▶ F 416: with adjustable tip valve ▶ F 416-1: without valve ▶ F 416-2: with ball valve 	<ul style="list-style-type: none"> ▶ Compressed air motor ▶ Extremely powerful ▶ Low-maintenance ▶ Cool running ▶ FPM 4: 0.6 kW at 6 bars for media up to 25,000 mPas ▶ FPM 6: 1.2 kW at 6 bars for media up to 50,000 mPas ▶ FPM 8: 2 kW at 6 bars also for paste-like media 	<ul style="list-style-type: none"> ▶ Three-phase motor ▶ Constant rpm ▶ Extremely low noise ▶ Available with 700 rpm or 930 rpm 	<ul style="list-style-type: none"> ▶ Spur gear drive motor ▶ With frequency control ▶ Adjustable speed 47-472 rpm 	<ul style="list-style-type: none"> ▶ Three-phase motor ▶ Low wearing ▶ Constant rpm ▶ Extremely low noise ▶ With speed 2,850 rpm for media with viscosity of up to 30,000 mPas ▶ With speed 1,450 rpm for media with viscosity of up to 80,000 mPas 	

Flow meters

For manual or semi-automatic filling of different fluids



FLUX flow meters constructed on the nutating disc principle (FMC), oval rotor (FMO) or the turbine principle (FMT), provide the right solution for every application. Depending on model and overall size they can be used on e.g. FLUX drum pumps or stationary e.g. in pipe lines. Using the digital display unit FLUXTRONIC® for FMC and FMO filling and metering processes can be carried out for virtually all liquids with maximum precision and the greatest possible safety. In automatic mode there is the possibility of transmitting signals for control purposes. In this way differing processes can be regulated.

Technical data



	FMC/FMO/FMT
Flow rate max.	Max. 380 l/min*
Viscosity max.	500,000 mPas*
Operating pressure max.	200 bars*
Application	Stationary or mobile with drum or eccentric worm-drive pumps



Semi-automatic can filling in explosion zone 1.

FLUXTRONIC®

Due to the digital display unit FLUXTRONIC® fitted to flow meters FMC and FMO there are two operating modes available. Whereas in "normal mode" only the flow volume is displayed, in automatic mode it is possible to fill pre-programmed amounts of liquid semi-automatically - at the push of a button. As soon as the desired quantity has been filled two signals can be transmitted. In this way for example a valve or drive motor can be controlled or the signal transferred to a PLC.



Digital display unit FLUXTRONIC® can be fitted to flow meter or directly to the hand nozzle.

Flow meter FMC

For low-viscosity fluids also slightly soiled



Advantages/characteristics:

- ▶ Constructed on the nutating disc principle
- ▶ Non sensitive to small particles
- ▶ Media temperatures up to 80 °C
- ▶ Easy handling
- ▶ High wear resistance – large choice of materials
- ▶ Non sensitive functional principle
- ▶ Low weight
- ▶ For low-viscosity media
- ▶ Operational in any installed position
- ▶ Can be calibrated

Examples of media:

Formic acid, arsenic acid, boric acid, brake fluid, calcium chloride, acetic acid, iron III chloride, glycol, sodium hydroxide, zinc chloride, citric acid, flammable media

Technical data	
Flow rate min.	10 l/min*
Flow rate max.	250 l/min*
Viscosity max.	2,500 mPas*
Operating pressure max.	6 bars*
Housing material	Polypropylene, Ethylene tetrafluorethylene, Stainless steel
Application	Stationary or mobile with drum pump*

Flow meter FMO

For pure fluids incl. high-viscosity liquids



Advantages/characteristics:

- ▶ Constructed on the oval rotor principle
- ▶ Very precise metering possible
- ▶ Media temperatures up to max. 120 °C
- ▶ High wear resistance
- ▶ Also for high pressures
- ▶ Extensive flow volume range
- ▶ Extensive viscosity range
- ▶ Can also be used with pulsating flows – e. g. in combination with compressed air-operated diaphragm pumps
- ▶ Low pressure loss
- ▶ Can be calibrated

Examples of media:

Oils, petrol, solvents incl. media which are not self-lubricating

Technical data	
Flow rate min.	0.04 l/min*
Flow rate max.	380 l/min*
Viscosity max.	500,000 mPas*
Operating pressure max.	200 bars*
Housing material	Polyvinylidene fluoride, Stainless steel, Aluminium
Application	Stationary or mobile with drum or progressive cavity pumps*

Flow meter FMT

For pure low-viscosity fluids

Advantages/characteristics:

- ▶ Constructed on the turbine principle
- ▶ For JUNIORFLUX/COMBIFLUX pumps
- ▶ Easy to handle
- ▶ For small quantities
- ▶ Simple counting unit – no evaluation possible

Examples of media:

Neutral, aggressive, low-viscosity, non-flammable liquids

Technical data	
Flow rate min.	5 l/min*
Flow rate max.	120 l/min*
Viscosity max.	40 mPas*
Operating pressure max.	10 bars*
Housing material	Polypropylen
Application	Mobile with JUNIORFLUX/ COMBIFLUX pumps

* dependent on version, material, overall size and media

MAGSON magnetically coupled centrifugal pumps

MAGSON – the hermetically sealed pump



Process pumps



Whether acids or alkalis – MAGSON magnetically coupled pumps for pumping highly aggressive media. Operating conventional centrifugal pumps with wear-prone shaft seals safely requires a great deal of technical and financial effort, especially when pumping highly aggressive media or media with a tendency to crystallise. The regular maintenance cycles required also reduce the availability of the system. The advantage of sealless, magnetically coupled centrifugal pumps: hermetically sealed and maintenance-free. The externally rotating drive magnet transmits the motor force to the internal magnet and thus to the impeller without contact. This means there is no need for a continuous shaft and consequently no need for a wear-resistant shaft seal to the motor. The pump chamber and drive are hermetically separated from each other by a containment shell. Leaks are excluded and the pumps are maintenance-free.

MAGSON sets standards in safety

MAGSON magnetically coupled centrifugal pumps go one step further: their robust design and a series of intelligent solutions increase resistance to highly concentrated acids and alkalis and provide greater safety in critical operating conditions.

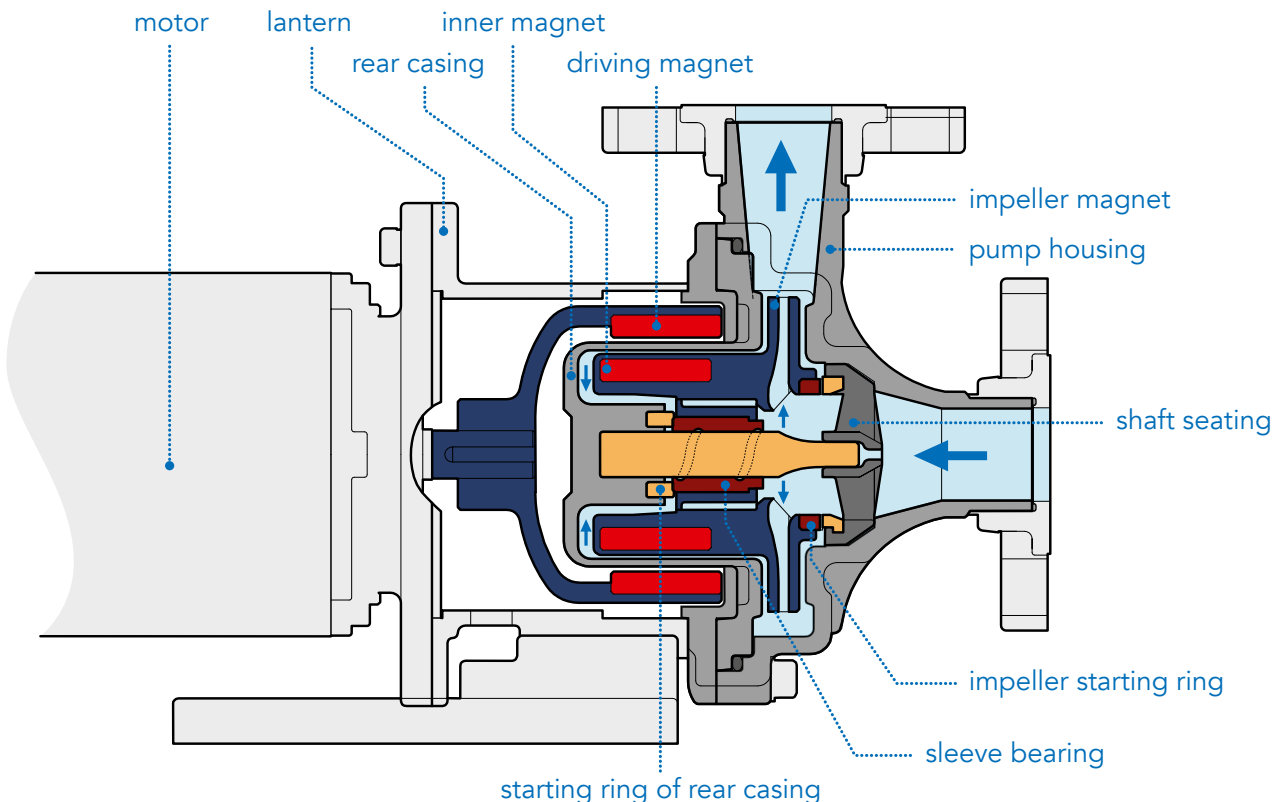

The way MAGSON magnetic centrifugal pumps work.

MAGSON MML

Stainless steel

The metal versions cover all areas where plastic cannot be used. Different impeller designs available. Also in ATEX design.

Main materials in 1.4401 (CF8M, 316L)



Technical data

Flow rate max.	500 l/min*
Head max.	24 mwc*
Viscosity max.	250 mPas*
Pump material	Stainless steel

MAGSON MMT

Stainless steel

Stainless steel peripheral impeller pump for high pressures and temperatures up to 300 °C, where plastic can no longer be used. Various impeller designs available. Also in ATEX design.

Main materials in 1.4401 (CF8M, 316L)



Technical data

Flow rate max.	170 l/min*
Head max.	80 mwc*
Viscosity max.	250 mPas*
Pump material	Stainless steel

MAGSON MA

Plastic injection moulding

Our flagship with the best price/performance ratio. Robust design, no shaft seal, therefore hermetically sealed, low operating costs thanks to particularly high efficiency, maintenance-free and much more.

Main materials in PP and ETFE



Technical data

Flow rate max.	950 l/min*
Head max.	42 mwc*
Viscosity max.	250 mPas*
Pump material	Polypropylene, Ethylene tetrafluoroethylene Fluoropolymer

* The maximum flow rate is a test bench value, measured with water at 20 °C at the pressure port of the pump, without accessories

MAGSON magnetically coupled centrifugal pumps

MAGSON – the hermetically sealed pump

MAGSON MAS

Plastic injection moulding, self-priming

In addition to the MAGSON MA, these pumps can suck in media from below using the integrated suction tank. Suction capacity of 5mWs in less than two minutes.

Main materials in PP and ETFE



Technical data

Flow rate max.	470 l/min*
Head max.	27 mwc*
Viscosity max.	250 mPas*
Pump material	Polypropylene, Ethylene tetrafluoroethylene Fluoropolymer

MAGSON MPT

Machined plastic, turbine wheel

This series is specially designed for high pressures at low flow rates. This pump is also available in an ATEX version.

Main materials in PP and PVDF



Technical data

Flow rate max.	215 l/min*
Head max.	55 mwc*
Viscosity max.	250 mPas*
Pump material	Polypropylene, Polyvinylidene fluoride

MAGSON MP

Machined plastic

The MP series is always used when the MA series can no longer be used due to conveying data. It can also be manufactured in an ATEX version.

Main materials in PP and PVDF



Technical data

Flow rate max.	2,000 l/min*
Head max.	44 mwc*
Viscosity max.	250 mPas*
Pump material	Polypropylene, Polyvinylidene fluoride

* The maximum flow rate is a test bench value, measured with water at 20 °C at the pressure port of the pump, without accessories

MAGSON GM

Plastic-lined version

The GM series, as a standardised chemical pump, is always used when pure plastic versions can no longer be used, e. g. due to pressure.

Main materials in GG/PFA



Technical data

Flow rate max.	500 l/min*
Head max.	24 mwc*
Viscosity max.	250 mPas*
Pump material	GG/PFA

MAGSON MAU

Plastic submersible motor pump

If your pump needs to be submerged, then the magnetically coupled pump type MAU is the right choice. It can be submerged and operated under liquid level.

Main materials in PP



Technical data

Flow rate max.	330 l/min*
Head max.	12 mwc*
Viscosity max.	250 mPas*
Pump material	Polypropylene

* The maximum flow rate is a test bench value, measured with water at 20 °C at the pressure port of the pump, without accessories

Centrifugal immersion pumps

For pumping and circulating large volumes incl. aggressive and abrasive media



Process pumps



FLUX centrifugal immersion pumps are used when larger flow rates, continuous running or special immersion lengths are required. They are especially suitable for pumping and circulating aggressive and abrasive media from small containers up to 4.1 m high tanks. There is a choice of different materials available depending on the chemical and thermal requirements. In addition sealless and horizontal versions are available. FLUX centrifugal immersion pumps are individually configured and manufactured according to the technical requirements in each case.

Technical data

Container/ application	IBCs, tanks as process pump
Flow rate max.	74 m ³ /h*
Head max.	35 mwc*
Viscosity max.	2,500 mPas*
Motor drive	Electric

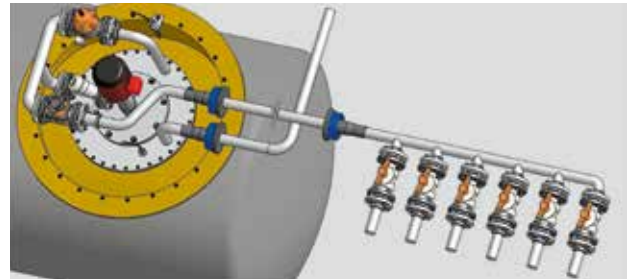

AdBlue[®] underground tank system – Supply of tap connection by FLUX centrifugal immersion pump F 640.



F 716 – Circulation of chemicals in an electroplating bath.



F 640 – Pumping of diluted sulphuric acid out of a pickling tank.

* The maximum flow rate is a test bench value, measured with water at 20 °C at the pressure port of the pump, without accessories (hose, nozzle, flow meter)

** AdBlue[®] is a registered trademark of: Verband der Automobilindustrie e.V. (VDA)

Series 600

Tank pump – for immersion lengths of up to 4,100 mm

Advantages/characteristics:

- ▶ Centrifugal pump
- ▶ Tank pump
- ▶ Suitable for tank heights up to 4.1 m without bottom opening
- ▶ Also pumps solids-laden fluids
- ▶ For mobile or stationary use
- ▶ Pump is hermetically tight
- ▶ Installation in pressurised tank or gas scrubber possible
- ▶ Motor replaceable
- ▶ Available as horizontal version for dry installation

Examples of media:

- ▶ Anodising solution
- ▶ Vegetable fibre suspension
- ▶ Water-based lacquers
- ▶ Alkaline pickling vats
- ▶ Industrial effluent
- ▶ AdBlue®**

Technical data	
Flow rate max.	42 m ³ /h*
Head max.	32 mwc*
Viscosity max.	2,500 mPas*
Pump material Outer tube	Polypropylene, Polyvinylidene fluoride, Stainless steel
Immersion length (mm) (standard)	700/1,000/ 1,500/2,000 (up to 4,100 mm on request)

Series 700

Stationary circulating and filter pump – can also be used for continuous running

Advantages/characteristics:

- ▶ Vertical centrifugal pump
- ▶ Suitable for continuous operation
- ▶ Maintenance-free
- ▶ Sealless in liquid zone
- ▶ Extremely long lifetime
- ▶ Highest stability from steel core in the inner tube; no longitudinal change at high or low temperatures

Examples of media:

- ▶ Electroplating baths with e. g. copper sulphate, chromium and zinc electrolytes
- ▶ Chemically aggressive liquids such as anorganic and organic acids, lyes and salts

Technical data	
Flow rate max.	74 m ³ /h*
Head max.	35 mwc*
Viscosity max.	150 mPas*
Pump material Outer tube	Polypropylene, Polyvinylidene fluoride
Immersion length (mm) (standard)	300/500/700/ 1,000

* The maximum flow rate is a test bench value, measured with water at 20 °C at the pressure port of the pump, without accessories (hose, nozzle, flow meter)

** AdBlue® is a registered trademark of: Verband der Automobilindustrie e. V. (VDA)

Air-operated diaphragm pumps

Self-priming pumps also for pumping abrasive media



FLUX compressed air-operated diaphragm pumps are self-priming and protected against dry running. The pumps are distinguished for their versatility and can be used for virtually all types of media. Available in heavy duty (RFM) or injection-moulded/cast (FDM) version for a huge diversity of applications they are designed for high pressures of up to 8 bars and in addition to other properties they are outstanding for their ease of handling. The 100% start-up guarantee in every shut-down position guarantees reliability and safe operation. The flow is infinitely variable via the air pressure. In addition the flow rate is easy to calculate. As a result of the integrated silencer the compressed air-operated diaphragm pumps are low noise. In addition the pumps are low-maintenance, in particular if used for pure media.

Advantages/characteristics:



- ▶ Sealless
- ▶ Conveying of abrasive, solid-containing and corrosive media
- ▶ Low-shear liquid transfer
- ▶ Dry-run safe
- ▶ Mobile and portable
- ▶ Self-priming
- ▶ Easy installation
- ▶ Low wear and tear
- ▶ Quick and easy maintenance

Metering/control:

- ▶ Versions with cycle control via solenoid valve available
- ▶ Version with fitted stroke counter available – combined with the evaluation unit FLUXTRONIC® it makes perfect metering possible (e. g. for colour mixing machines; for filling paint robots)



FDM: Pumping of chemical nickel for electroplating bath.



RFM: Pumping of concrete additives from IBCs into mixing tower.

* The maximum flow rate is a test bench value, measured with water at 20 °C at the pressure port of the pump, without accessories (hose, nozzle, flow meter)

RFM
Heavy duty construction

Advantages/characteristics:

- ▶ Almost completely diffusion resistant due to the thick-surface structure
- ▶ Virtually no passive corrosion
- ▶ Due to composite enduring membrane even at high pressures
- ▶ Versions available with flap valves
- ▶ Extremely long service life even with abrasive media (e. g. enamels, slurries or abrasive glass dust)
- ▶ Quiet/low noise
- ▶ Versions available for use in hazardous areas
- ▶ FDA-certified version available

Examples of media:

- ▶ Highly concentrated sodium hydrochlorite
- ▶ Media containing chlorine
- ▶ Effluent from industrial hardening machinery
- ▶ Solvent mixtures
- ▶ Pickling vats

Technical data	
Flow rate max.	375 l/min*
Head max.	70 mwc*
Operating pressure max.	7 bars
Suction head product filled to max.	8 m*
Suction head dry max.	4.5 m*
Viscosity max.	15,000 mPas
Solid matter size max.	50 mm*
Housing material	Polypropylene, Polypropylene conductive, Polytetrafluorethylene, Polytetrafluorethylene conductive

FDM
Injection-moulded/cast version

Advantages/characteristics:

- ▶ Available in plastic and as metal version
- ▶ Oil-free operation
- ▶ Regulating valve insensitive to foreign matter in the air
- ▶ Version for increased pressure (3:1)
- ▶ Versions available for use in hazardous areas

Examples of media:

- ▶ Alcohols in pharmaceutical sector
- ▶ Petrol
- ▶ Chlorine bleach
- ▶ Cleaning agents
- ▶ Pickling
- ▶ Effluent

Technical data	
Flow rate max.	1,040 l/min*
Head max.	200 mwc*
Operating pressure max.	8,6 bars
Suction head product filled to max.	9.5 m*
Suction head dry max.	4.5 m*
Viscosity max.	15,000 mPas
Solid matter size max.	50 mm*
Housing material	Polypropylene, Acetal conductive, Polyvinylidene fluoride, Aluminium, Stainless steel, Grey cast iron

* The maximum flow rate is a test bench value, measured with water at 20 °C at the pressure port of the pump, without accessories (hose, nozzle, flow meter)

Filling systems

Manual and semi-automatic metering systems for use with drum pumps



FLUX filling systems provide everything required for the fast and safe emptying of containers. They provide an economical alternative to conventional automatic filling machinery and stations. A FLUX filling system is comprised of a combination of suitable drum pump and drive motor specially configured for the application, hose line and discharge fitting. Metering via the discharge fitting can be made either manually by using a hand nozzle or semi-automatically in combination with a flow meter via the FLUX discharge unit with spring valve (FAE).

Manual filling systems

For fast and safe filling of various media from drums and IBCs

There is a choice of pre-configured pump sets consisting of the components drum pump, drive motor, hose line and hand nozzle. These are available for:
Acids and lyes, concentrated acids and AdBlue[®],
mineral oil products, highly flammable liquids,
universal applications; 99.98% drum emptying

Furthermore all pumps can be combined with individually selectable accessories to form a customized set for the particular application. For example together with a flow meter for improved metering.



Semi-automatic filling systems

Fast and safe metering of preset quantity

Advantages/characteristics:

- ▶ Fill quantity setting via FLUXTRONIC[®]
- ▶ Economic alternative to conventional automatic filling machines and stations
- ▶ Comprising drum pump, drive motor, hose line, flow meter, circuit amplifier and FLUX discharge unit with spring valve
- ▶ Discharge fitting – semi-automatic; filling operation is controlled via start/stop button



Filling systems

Pump kit SAFETEC and FLUX FILL-GT



SAFETEC pump kit

The requirements regarding environmental protection and sustainability as well as safety when handling hazardous chemicals are constantly increasing. For these reasons, more and more chemical packaging is being brought onto the market as drums or IBC containers that are sealed and emptied via a permanently installed dip tube using the suction method.

Sealed containers cannot be emptied using conventional drum or container pumps, as there are no longer any openings for inserting a drum pump. Instead, the containers must be emptied through the dip tube using the suction method with self-priming pumps. We have developed the SAFETEC pump set for this purpose. Optionally with integrated volume measurement and dosing control for effective filling of containers.

Main pump material in PP or ETFE,
Pipework in PVC or PVDF

System solutions



The compact, semi-automatic filling system with weighing technology

With the FLUX FILL GT semi-automatic filling system, low-viscosity and slightly foaming fluids can be filled quickly, efficiently and safely. The system works with accurate weighing technology and thus enables filling in accordance with the Prepackaging Ordinance (FPackV). The integrated filling programme management allows the fluids to be easily filled into a wide variety of containers using the over-level method. The system is therefore particularly suitable for filling small and medium-sized container batches, with and without container changeover – for internal use as well as for sales.

Can be driven by hermetically sealed, self-priming magnetic pumps or many other pump systems.

Combined with other products from the FLUX range of pumps and accessories, the feed side can also be optimised for the application. In this way, a compact, semi-automatic filling system can be configured from the filling system and feed components.

Note

Also available in the FLUX FILL VM version – with volumetric filling measurement

Drum emptying systems VISCOFLUX

For pumping high-viscosity media out of lidded drums



left: VISCOFLUX mobile S, right: VISCOFLUX lite.

VISCOFLUX drum emptying systems were specially developed for emptying lidded drums with high-viscosity contents. The medium is continuously and particularly carefully extracted with FLUX eccentric worm-drive pumps. All systems achieve an almost complete emptying of the drum with < 1% residual amount (under 2% for drums with liners).

Whereas the VISCOFLUX lite is ideal for pumping high-viscosity media barely capable of flowing, the VISCOFLUX mobile S is capable of pumping highviscosity media not even capable of flowing by themselves.

VISCOFLUX lite

The FLUX specialist for pumping high-viscosity media just capable of flowing.



Advantages/characteristics:

- ▶ Only a few components means fast fitting
- ▶ For ISO lidded drums with outside Ø 571.5 mm
- ▶ Non-explosion protected version designed for pump with Ø 54 mm, Ex-protected version for pump with Ø 50 mm

Examples of media:

- ▶ From media barely capable of flowing to grease classification 2
- ▶ Soft lubricating grease (NLGI classification 0-2)
- ▶ Base material for lacquers, adhesives, construction bonds and fixing compounds

VISCOFLUX mobile S

The stand-alone solution for pumping high-viscosity media



Advantages/characteristics:

- ▶ Stand-alone system uses mobile process equipment
- ▶ Easy to clean
- ▶ Also for conical, board and seaworthy container drums
- ▶ Various control possibilities optional
- ▶ FLUX FOOD version available, suitable for foodstuffs according to EC 1935/2004 and FDA CFR 21

Examples of media:

Industrial version:

- ▶ Coating and casting compounds
- ▶ Lacquers

Pharmaceuticals, foodstuffs and cosmetic sector version:

- ▶ Tomato purée (also from drums with liners)
- ▶ Creams and ointments e. g. zinc oxide ointments
- ▶ Vaseline



Example: concentrated tomato paste.



Emptying with the VISCOFLUX mobile S.

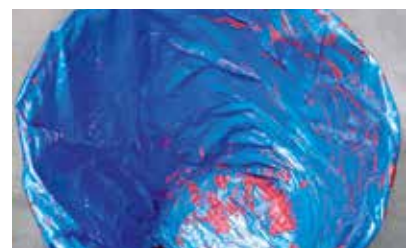

Residual quantity in the drum < 2%.

Customized all-in solutions

From pump kits to comprehensive systems



FLUX offers a lot more than just pumps. As well as a great diversity of pumps and suitable motors FLUX has an extensive range of ancillary products and accessories. After the analysis of the problem by the FLUX consultant complete customized solutions are developed. These can extend from small-scale product configurations through to complex systems.

Practical examples of customized all-in solutions by FLUX:

Task:

Filling of 10, 20 and 60-l-cans and 200-l-drums from IBC stacked or on racking.

Components used:

- ▶ FLUX drum pump F 430 S TR
- ▶ FLUX commutator motor F 457
- ▶ PVC hose
- ▶ FLUX flow meter FMC 100 in stainless steel with digital display unit FLUXTRONIC®
- ▶ 2-way valve
- ▶ Circuit amplifier FSV 100 for controlling the motor and 2-way valve
- ▶ Mineral oil hose integrated
- ▶ Wired in filling unit
- ▶ Stainless steel panel (mounted to the struts of the IBC)

Advantages/characteristics:

- ▶ Quantity to be filled is preset via the FLUXTRONIC® and filling is started by pressing a button on the filling unit



Media: Mineral oils and machining oils.

Task:

Suction of a cleaning agent from the basement and filling into different containers depending on the application

Components used:

- ▶ FLUX Self-priming centrifugal pump MAS as pump set SAFETEC (not shown)
- ▶ SAFETEC set (not shown in the picture)
- ▶ Fixed pipework between pump set and filling station
- ▶ FLUX SAFETEC control unit Comfort-D (2-fold)
- ▶ Filling lance with FLUX SAE for low-foaming filling
- ▶ Adjustable stop for different containers
- ▶ Switchover from filling via lance to hose filling (also with FLUX SAE for low-foaming filling)

Advantages/characteristics:

- ▶ Personnel and the environment are relieved and protected
- ▶ Medium is conveyed and filled safely and conveniently
- ▶ Stainless steel table for ergonomic working



Media: Cleaning agent.

Mixers

Can be custom configured for any mixing operation



Anyone who wants to disperse, emulsify, homogenise, chill, dissolve, mix, neutralise, stir, circulate or exchange heat efficiently is faced with a demanding task – from a technical and physical point of view. The mixing effect that flows develop depends on the shape of the container, the material and of course the type of mixer. Due to the flexible modular system FLUX is able to offer a wide range of options. This makes it possible to configure the mixer components of motor, shaft and mixing blade optimally for the application's requirements.

Fast runners

For low to medium viscosity media and small containers

Advantages/characteristics:

- ▶ Circulating performance up to 650 m³/h
- ▶ Speeds 750–1,500 rpm
- ▶ Several mixing blades can also be mounted on top of each other
- ▶ Ideal for liquids of up to 2,500 mPas
- ▶ Configured for fluids with max. 5% solid content
- ▶ Suitable for IBCs and tanks of up to approx. 4,000 l
- ▶ For continuous flow systems with 5–20 fold flow per hour

Examples of media:

- ▶ Milk of lime with solution of up to 5%
- ▶ For chemicals use e.g. aluminium sulphate, ferric chloride



Slow runners

For high circulation performance

Advantages/characteristics:

- ▶ Circulating performance up to 3,600 m³/h
- ▶ Low speed of approx. 70 rpm
- ▶ For fluids of up to a viscosity of 10,000 mPas
- ▶ With gear
- ▶ Versions available with sliding or folding agitators
- ▶ Can be used in tanks
- ▶ For liquids with max. 10% solids
- ▶ For run-through systems with 10–40 fold flow per hour

Examples of media:

- ▶ Milk of lime with solution of up to 30%
- ▶ Flocculant additive with a viscosity of 300 mPas



Filters and Filter housings SONCO

SONCO – clean and safe



New generation filter chambers, -devices and -skids made of plastics; either PP or PVDF

It is FLUX's principle to always think one step ahead. And so we didn't just develop a new filter, but took a close look at each individual part and analysed how it could be improved in terms of customer benefit.

The result: SONCO filters. SONCO filters are the perfect solution when it comes to absolute tightness and reliability in the filtration of highly aggressive acids and alkalis, degreasing baths, chemicals and highly corrosive liquids. The highest product quality and innovative design guarantee maximum efficiency and flexibility in the process. In conjunction with the comprehensive FLUX service, this ensures that you can operate your systems reliably in the long term.

Advantages in detail

All-plastic design made of PP/PVDF

Metal-free design in the area in contact with the product ensures the best possible chemical resistance. Solid welded construction made of semi-finished products without glass fibre content.

Complete splash protection

All SONCO filter chambers are equipped with a complete splash guard that also reliably covers the cover screw areas. This protects the operator in the event that medium escapes through a lid screw connection that is not fully tightened.



Lid opened



Splash guard closed



Filter closure with hinged lid

The filter cover is closed using hinged screws with easy-grip toggles. The open lid remains on the filter chamber and does not need to be lifted off separately.

Flow-optimised design

The internal fluid routing is optimised to minimise pressure losses. The flow towards the filter elements is as homogeneous as possible flow velocity in order to load the filter elements evenly.

Pressure gauge and drain cock as standard

All filter chambers from size 3 are fitted with a pressure gauge and drain cock as standard (optional for size 1).

Filters and Filter housings SONCO

SONCO – clean and safe

SONCO Filter

Filter housings made of PP or PVDF

SONCO-Filter housings are available in two designs.

Type FKX filters are universal which means they can accept a variety of filter media with different inserts. This makes it incredibly easy to change the method of filtration between cartridges, plate filters, activated carbon or oil absorbent filters.



SONCO Filter chambers

FKB for bag filters

The filter chambers FKB, on the other hand, are only suitable for bag filters, since here the direction of flow must take place directly from above via the cover to ensure filtration. It also makes it easy to change the bag.



SONCO Filter technology

Filter devices

SONCO-Filtration system consists of:

- ▶ A polypropylene constructed baseplate/stand to hold all components
- ▶ A filter housing with filter insert and filter media
- ▶ Complete piping of all components
- ▶ as well as a MAGSON pump



SONCO Filter technology

Skids

Special tasks require special solutions. That is why we design, plan and build filter systems according to your requirements. We will discuss the task with you on site and thus develop an optimal solution. Measurement, planning, 3D simulation and construction as well as the assembly come from a single source – the best possible guarantee that all interfaces fit together and that the system is ergonomically easy to operate.

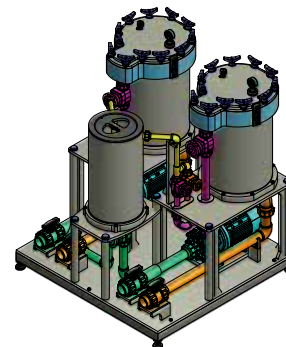

Cartridge filter

Insert for filter cartridges with an outer diameter of 63 mm. Particularly easy handling by cartridge tie rod with large, grippy clamping screws.

- ▶ Versatile depth filter
- ▶ Filtration direction from outside to inside
- ▶ Easy handling, quick cartridge change
- ▶ High dirt capacity for long service life



Bag filter

Filter bags are surface filters. As an absolute filter, 100% of all particles larger than the nominal filter fineness are retained. Filter finenesses from 1–500 μ .

- ▶ Filter cake stays in the bag and does not fall back into the bath
- ▶ Filtration direction from top to bottom
- ▶ Easy to use
- ▶ The filter cloth is easy to wash off
- ▶ The filter bag can be used several times depending on the nature of the contamination



Activated carbon

Activated carbon is a highly porous, pure carbon with a high surface area (up to 300 m² per gram). Activated carbon is used to absorb organic substances, odors and flavors.

- ▶ Easy and clean charcoal treatment possible thanks to canister insert
- ▶ Long contact time due to low flow rates in the canister increases efficiency
- ▶ Filter cartridge as a retaining element prevents the activated carbon from washing out



Oil absorbens

For absorption of oils and fats e.g. from degreasing baths. Reduces the use of surfactants and extends bath life. As a filter medium special fibres are introduced into the canister.

- ▶ Canister insert with extractor makes it clean and easy to change the filter



Plate filter

Plate filter insert with filter paper for surface filtration.

- ▶ Filter cake builds on the paper discs between the filter plates
- ▶ Average dirt capacity
- ▶ Low waste volume
- ▶ Inexpensive consumables!
- ▶ Suitable for the universal filter chamber FKX
- ▶ Easy removal of the insert by means of a pull-out handle



Additional products and accessories

Comprehensive range of accessories for all FLUX pump models



To supplement the diverse range of pumps FLUX has a wide range of accessories on offer. Whether for mobile or static deployment – with the FLUX range of accessories a FLUX pump can be turned into a custom-made pumping system for any area of application or purpose. It provides smooth and safe running and at the same time makes work easier. For example it is possible to lift a FLUX pump out of the drum without any exertion thanks to the stirrup handle and spring balance. Space saving storage equipment allows pumps to be economically stored. Furthermore for every application there is e.g. the right hose – pre-configured and integrated in the required length. For typical drum pump applications there are pre-configured pump sets available.

Fume gland

For aggressive and corrosive media

Advantages/characteristics:

- ▶ Hermetically seals container
- ▶ The venting valve ensures that the pressure of the tank being emptied is compensated
- ▶ Optimum protection for operator and environment
- ▶ Where necessary the motor is protected from corrosive vapours
- ▶ Designed for FLUX drum pumps series 300, 400 and 500

Examples of media:

Acids, lyes and media with aggressive and hazardous vapours

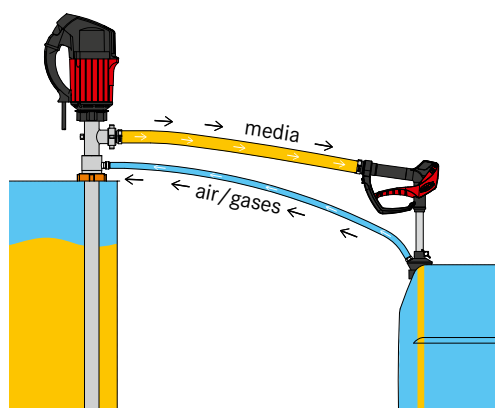

Hand nozzles

For simple filling

Advantages/characteristics:

- ▶ Ergonomically shaped hand lever
- ▶ Easy to operate
- ▶ Fine metering
- ▶ Ball-bearing mounted swivel joint
- ▶ Low pressure loss
- ▶ High flow rate
- ▶ Can be combined with stop valve, emission-protection cone and various outlet nozzles

Examples of media:

Boric acid, phosphorous, hydrochloric acid and sulphuric acid, potassium and sodium hydroxides, ammonium water and hydrobromic acid



Dry-running and no-load sensors

The TLS dry-running sensors detect air bubbles in conductive media and can thus protect the pump from running dry or empty. The TLS is available in two versions: the TLS-1 for installation in the pipework and the TLS-2 for mounting on existing pipework.



Hoses

Whether for use in the chemical, food, pharmaceutical, cosmetics or hazardous areas: FLUX has the right hose for every application – pre-assembled and integrated in the required length.



Handling

Accessories for safe handling and making work easier

Accessories for handling ensure smooth and safe operation as well as making work easier. For example, a FLUX pump can be lifted out of the drum without effort thanks to the retaining bracket and spring balancer.

- ▶ Wall bracket
- ▶ Spring balancer
- ▶ Quick action balancer
- ▶ Attachment clamp
- ▶ Carrying handle
- ▶ Compression gland



Additional products and accessories



Today the FLUX name is recognised around the globe as the trademark for top standards in pump technology. Everything started with the invention of the electric drum pump in 1950. Nowadays FLUX has an extensive range of products each of which can be customized. FLUX pumps are used for example in the chemical and pharmaceutical industries; in machinery and plant engineering as well as companies in electroplating, effluent treatment and the foodstuffs sector.

Whether single-product or system solution – FLUX quality is synonymous with a long service life, excellent economy and maximum safety.

In addition to the excellent product quality FLUX customers appreciate the superb level of expertise our staff has to offer as well as their genuine customer focus.

These days FLUX-GERÄTE GMBH supplies pumps to almost 100 countries around the globe.

FLUX-GERÄTE GMBH

Mobile Pumps

Talweg 12 · D-75433 Maulbronn

Tel. +49 7043 101-0 · Fax +49 7043 101-444

info@flux-pumpen.de · www.flux-pumps.com

FLUX-GERÄTE GMBH

Process Pumps & Systems

August-Horch-Straße 2 · D-51149 Köln

Tel. +49 2203 9394-0 · Fax +49 2203 9394-48

info-process@flux-pumpen.de · www.flux-pumps.com