

Alfa Laval Unique Mixproof Process

Double Seat valves

Introduction

The Alfa Laval Unique Mixproof Process valve is a versatile, double block-and-bleed valve that enables the simultaneous flow of two products or fluids through the same valve in valve matrices and pipelines without the risk of cross-contamination. This double seat valve with seat lift is a compact, cost-effective version of the premium Alfa Laval Unique Mixproof valve. High cleanability, the ability to withstand pressure peaks and its fit-for-purpose components make this valve a great addition to dairy, food and beverage applications. It comes in various sizes to meet your fundamental hygienic processing requirements.

Applications

The Alfa Laval Unique Mixproof Process is designed for continuous flow management and process safety in hygienic processes where product safety is at the top of the agenda across the dairy, food, beverage and many other industries.

Benefits

- Get the product safety you need by eliminating the risk of cross-contamination and product loss while ensuring efficient cleaning
- Enhance the reliability and flexibility of your process setup with proven valve technology tailored to your specific production needs, minimize the risk of unplanned downtime while spending as little time and resources as possible on routine maintenance
- Limit your environmental impact with significantly reduced water and CIP media consumption, no spillage and eliminated product loss
- Predefined and available in various sizes to meet your fundamental hygienic processing requirements

Standard design

The valve comprises a series of base components, including a proven valve body, valve plug and seals, maintenance-free actuator, and seat lift cleaning. Leakage detection holes enable visual inspection without requiring valve disassembly, alerting operators of the need for parts wear replacement. Few straightforward, moveable parts contribute to reliable operation and reduced maintenance costs. The valve can also be fitted with an Alfa Laval ThinkTop sensing and control unit.



Working principles

The Alfa Laval Unique Mixproof Process valve is a normally closed (NC) valve controlled remotely using compressed air. The valve has two independent plugs and seals to separate the liquids; the space between the seals forms a leakage chamber at atmospheric pressure under every operating condition. Leakage rarely occurs, but should it happen, the product flows into the leakage chamber and drains through the outlet at the bottom of the chamber for easy detection.

When the valve is open, the leakage chamber is closed. The product then flows from one line to the other. The well-known radial design of the valve ensures that virtually no product spillage occurs during valve operation.

Certificates

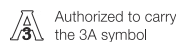

TECHNICAL DATA

Pressure	
Max. product pressure:	1000 kPa (10 bar) / 145 PSI
Min. product pressure:	Full Vacuum
Air pressure range:	600-800 kPa (6-8 bar) / 87-116 PSI

Temperature	
Temperature range:	EPDM -5 °C to +125 °C / 23 °F to 257 °F

ATEX	
Classification:	II 2 G D ¹

¹ This equipment is outside the scope of the directive 2014/34/EU and must not carry a separate CE marking according to the directive as the equipment has no own ignition source

PHYSICAL DATA

Materials	
Product wetted steel parts:	1.4404 (316L)
Other steel parts:	1.4301 (304)

Surface finish	
External (semi-bright):	Ra < 1.6 µm / Ra < 64 µi
Internal (polished):	Ra < 0.8 µm / Ra < 32 µi

Product wetted seals	
Sealing Material:	EPDM, FPM, HNBR

Other seals	
Actuator seals:	NBR
Guide strip:	PTFE

Valve body combination

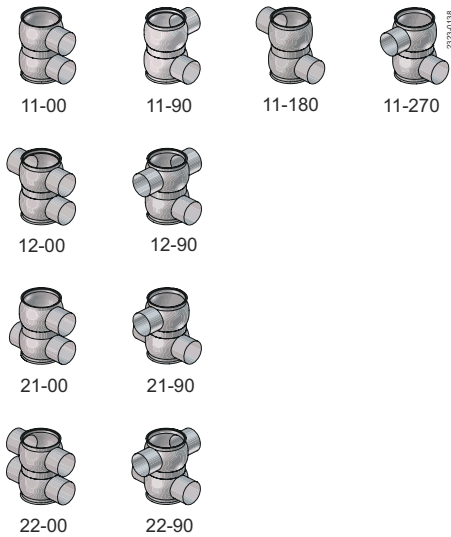

Valve body combinations, example: type 11-00

1 Number of ports - lower valve body

1 Number of ports - upper valve body

00 Angle between

Pressure drop/capacity diagrams

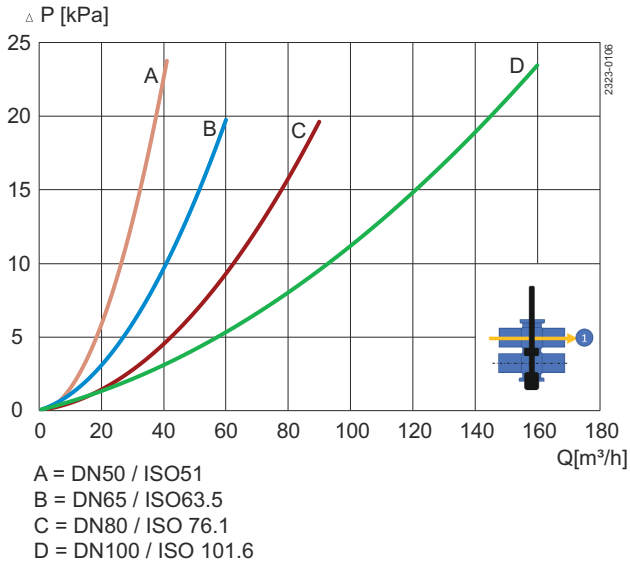

Figure 1. Pressure drop/capacity diagram, upper body

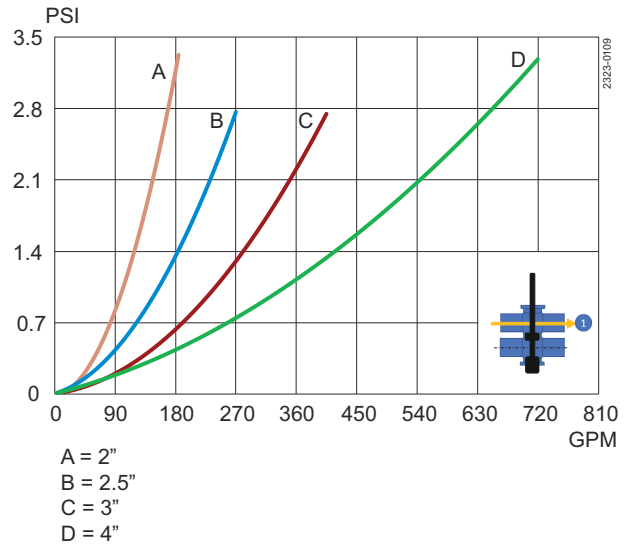

Figure 2. Pressure drop/capacity diagram, upper body

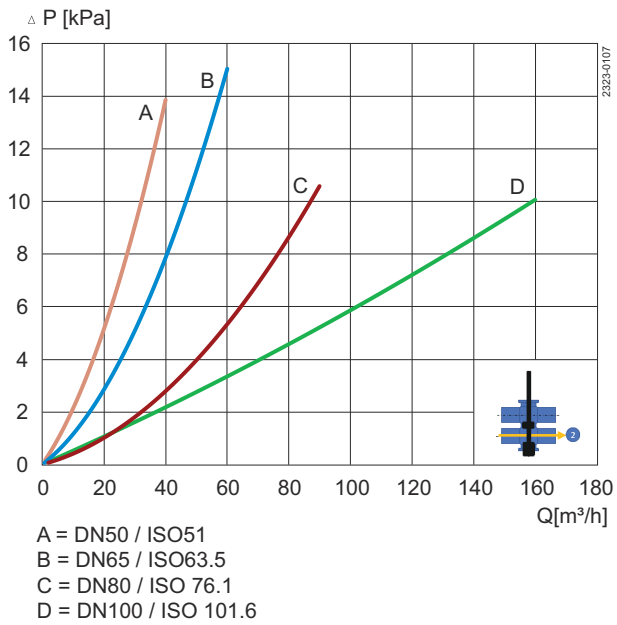

Figure 3. Pressure drop/capacity diagram, lower body

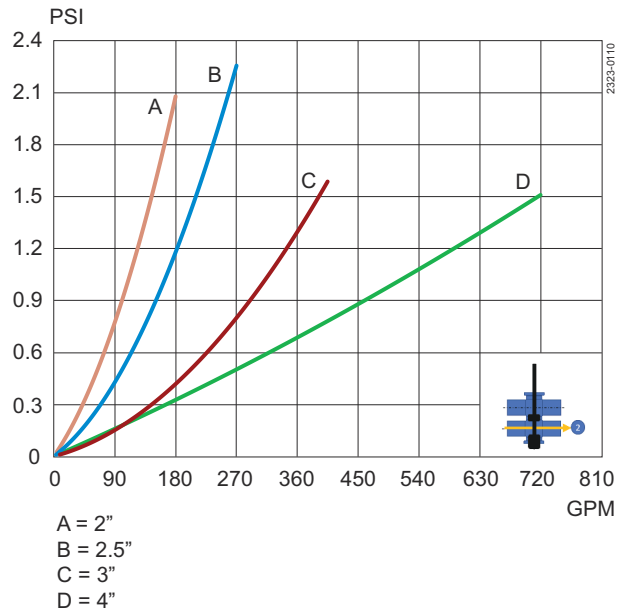

Figure 4. Pressure drop/capacity diagram, lower body

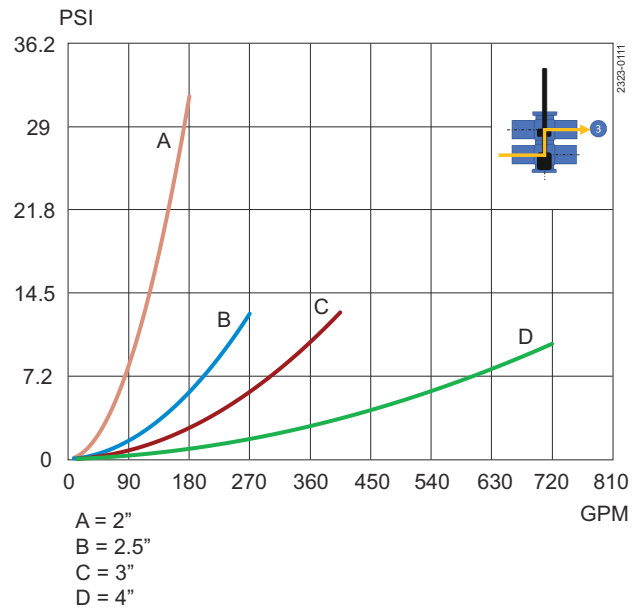
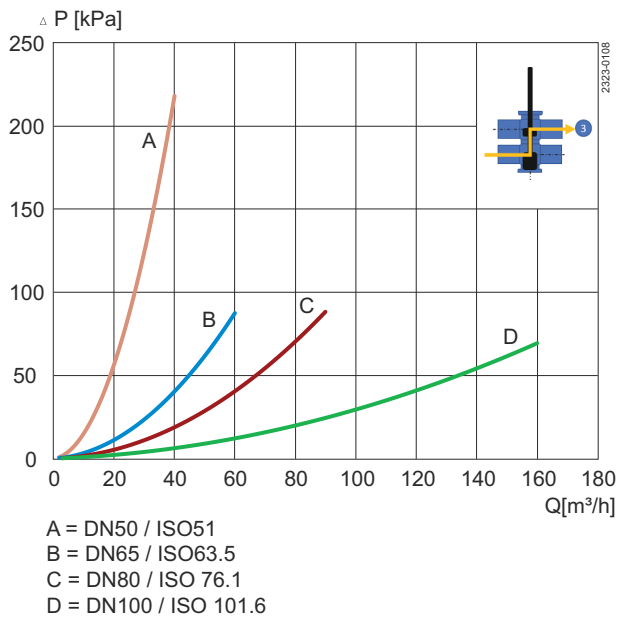

Figure 5. Pressure drop/capacity diagram, between bodies Figure 6. Pressure drop/capacity diagram, between bodies

Air and CIP consumption

Between bodies

Size	DN/OD				DN			
ISO/DIN	51	63.5	76.1	101.6	50	65	80	100
Kv-value [m ³ /h]	26.9	64.3	95.8	194.5	26.9	64.3	95.8	194.5
Cv-value [gpm/psi]	31.1	74.3	110.8	224.8	31.1	74.3	110.8	224.8

Size	DN/OD				DN			
ISO/DIN	51	63.5	76.1	101.6	50	65	80	100
Kv-value								
Upper Seat-lift [m ³ /h]	1.28	1.68	1.92	2.69	1.28	1.68	1.92	2.69
Lower Seat-push [m ³ /h]	0.81	1.33	1.90	1.92	0.81	1.33	1.90	1.92

Air consumption								
Upper Seat-lift [n litre]	0.02	0.02	0.08	0.08	0.02	0.02	0.08	0.08
Lower Seat-push [n litre]	0.97	0.97	2.76	2.76	0.97	0.97	2.76	2.76
Main Movement [n litre]	0.55	0.55	1.31	1.31	0.55	0.55	1.31	1.31

Size	OD			
ISO	51	63.5	76.1	101.6
Cv-value				
Upper Seat-lift [gpm/psi]	1.48	1.95	2.23	3.11
Lower Seat-lift [gpm/psi]	0.94	1.53	2.19	2.22
Air consumption				
Upper Seat-lift [cubic inches]	1.41	1.41	4.70	4.70
Lower Seat-lift [cubic inches]	59.23	59.23	168.38	168.38
Main Movement [cubic inches]	33.78	33.78	79.86	79.86

Burst seat clean nominal consumption

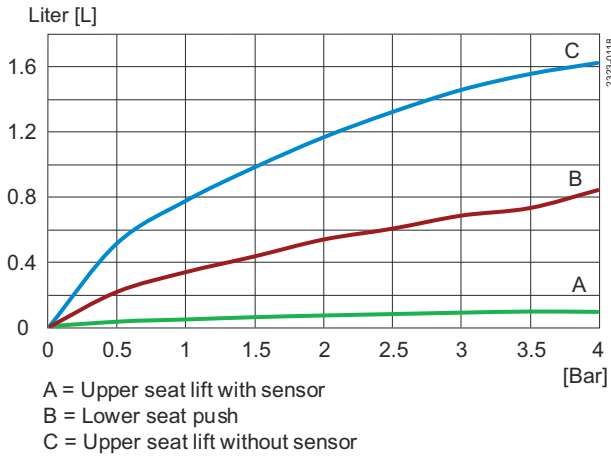

Figure 7. Unique Mixproof Process ISO51/DN50

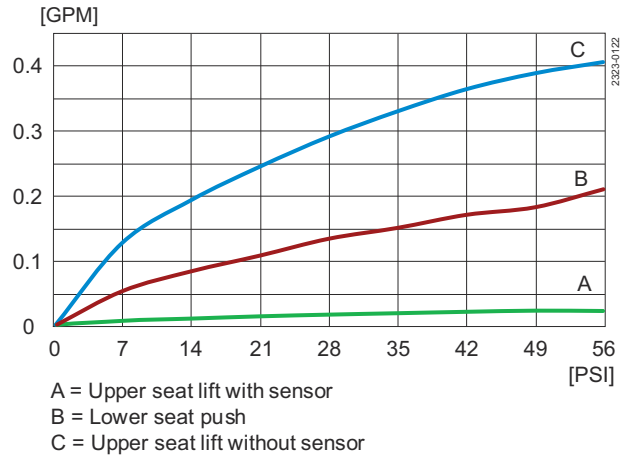

Figure 8. Unique Mixproof Process 2"

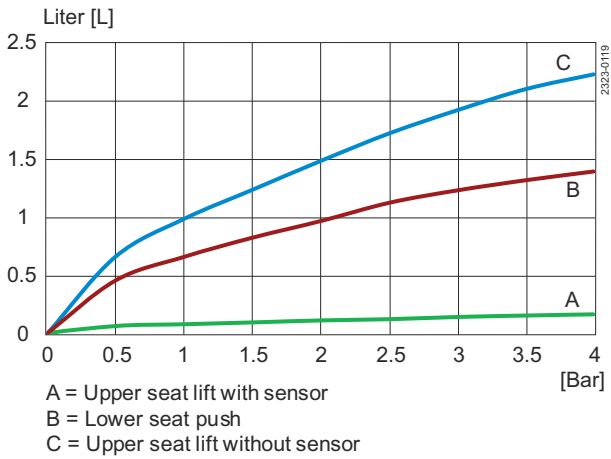

Figure 9. Unique Mixproof Process ISO63.5/DN65

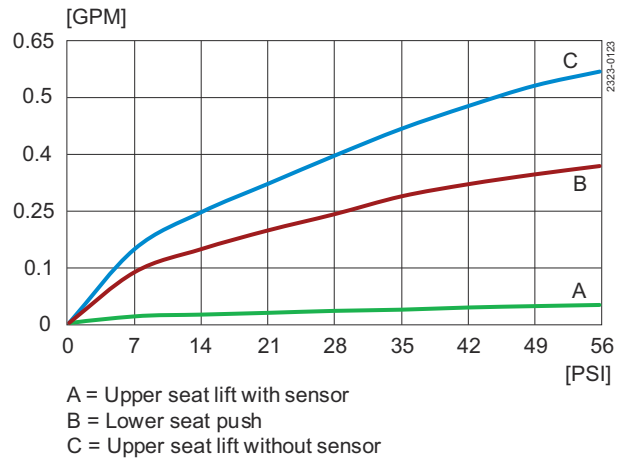

Figure 10. Unique Mixproof Process 2.5"

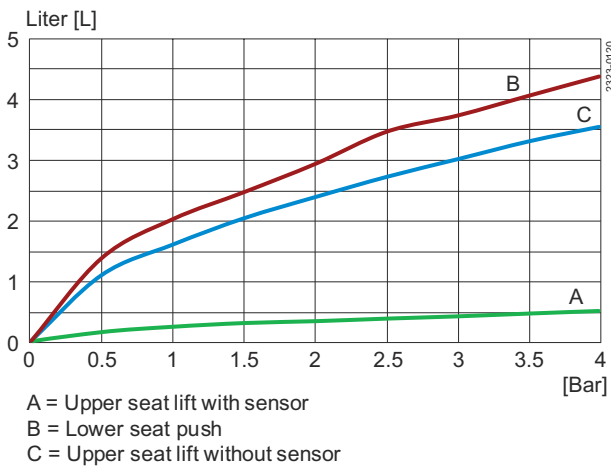

Figure 11. Unique Mixproof Process ISO76.1/DN80

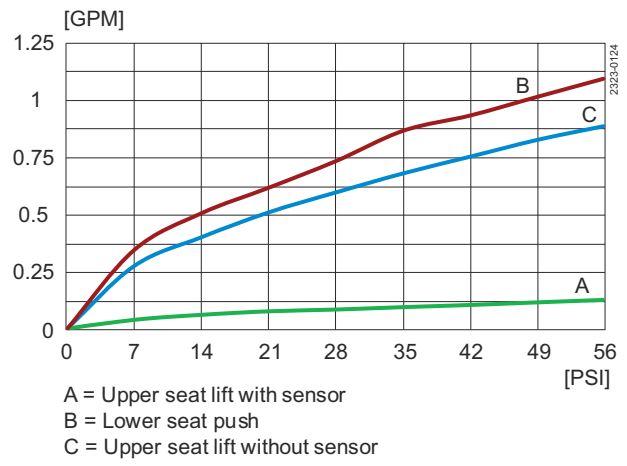

Figure 12. Unique Mixproof Process 3"

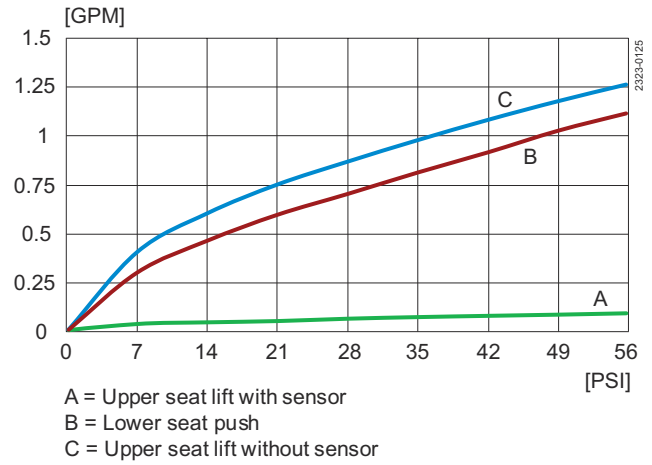
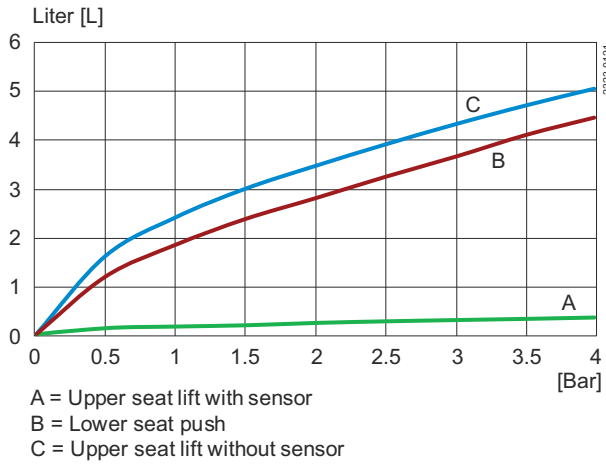
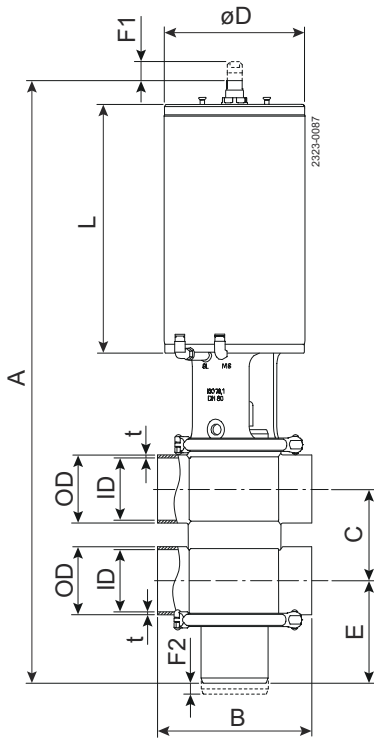

Figure 13. Unique Mixproof Process ISO101.6/DN100

Figure 14. Unique Mixproof Process 4"

Dimensions



(mm)

Size	DN/OD				DN			
ISO/DIN	51	63.5	76.1	101.6	50	65	80	100
A	519	547	676	718	521	553	684	720
B	122	162	172	238	122	162	172	240
C	73.8	86.3	98.9	123.6	76	92	107	126
OD	51	63.5	76.1	101.6	53	70	85	104
ID	47.8	60.3	72.9	97.6	50	66	81	100
t	1.6	1.6	1.6	2	1.5	2	2	2
E	92	101	121	126	90	98	117	125
F1	30.5	30.5	43	43	30.5	30.5	43	43
F2	7	7	7	7	7	7	7	7
ØD	115	115	157	157	115	115	157	157
L	205	205	278	278	205	205	278	278
Weight (kg)	11.4	13.6	24.4	27.6	11.5	13.9	24.9	27.7

(inch)

Size	OD			
ISO/DIN	2"	2½"	3"	4"
A	20.44	21.55	26.60	28.27
B	4.80	6.38	6.77	9.37
C	2.91	3.40	3.89	4.87
OD	2.01	2.50	3.00	4.00
ID	1.88	2.37	2.87	3.84
t	0.06	0.06	0.06	0.08
E	3.60	3.97	4.75	4.97
F1	1.20	1.20	1.69	1.69
F2	0.28	0.28	0.28	0.28
ØD	4.54	4.54	6.20	6.20
L	8.06	8.06	10.94	10.93
Weight (lb)	25.2	30.0	53.9	60.9

This document and its contents are subject to copyrights and other intellectual property rights owned by Alfa Laval AB (publ) or any of its affiliates (jointly "Alfa Laval"). No part of this document may be copied, re-produced or transmitted in any form or by any means, or for any purpose, without Alfa Laval's prior express written permission. Information and services provided in this document are made as a benefit and service to the user, and no representations or warranties are made about the accuracy or suitability of this information and these services for any purpose. All rights are reserved.

200008487-6-EN-GB

© Alfa Laval AB

How to contact Alfa Laval

Up-to-date Alfa Laval contact details for all countries are always available on our website at www.alfalaval.com