

SINGLE SEALING DIVERT VALVE

DCX4



TECHNICAL ADVANTAGES

DCX4

SINGLE SEALING DIVERT VALVES

The DEFINOX DCX4 divert valve has been designed to efficiently respond to market requirements, both from a cleanability and an operational point of view.

Its different configurations incorporate the cutoff, tapoff and orientation functions.

With their simple design, which has been tried and tested for many years, the floating PFA seal divert valves have successfully passed the EHEDG and 3A tests, guaranteeing their hygienic design, which is particularly suitable for the food-processing industries.

The modular design facilitates the component interchangeability and incorporates a wide range of options and variants. DCX range divert valves can thus cover a large range of applications and process configurations, while at the same time meeting market expectations and requirements.

They are fitted as standard with a floating PFA seal plug ensuring excellent valve cleaning.



PRODUCT BENEFITS DCX4

- + **From DN 25 to DN 150**
SMS-DIN and US versions.
- + **Floating PFA seal, perfectly cleanable**, ensuring perfect leaktightness at high temperature and good resistance to chemical products.
- + **Spherical body with thick walls ensuring** excellent resistance to expansion stresses and optimum cleanability.
- + **Can be used in numerous applications and configurations**
 - Various sealing solutions (different grades of latest generation elastomer – PFA).
 - Different body configuration options: L/L - L/T - T/L - T/T - L/X.
 - Numerous end connections possible: SMS - DIN - Clamp.
- + Removable and easily transformable pneumatic actuator: **NO-NC-Double acting**.
- + **Easy and quick maintenance** thanks to the clamp subassembly assembly.



The DCX4 divert valves are fitted as standard with a one-piece plug with a floating PFA seal.



PFA DCX4 balanced version
It integrates a fixing system, which avoids the release of the plug. Equipped with one-piece plug and floating PFA seal.

DEFORMABLE PTFE DIAPHRAGM BARRIER EFFECT

DCX4 STANDARD VALVE

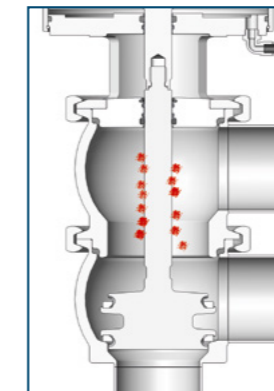

Valve closed

DCX4 DIAPHRAGM VALVE

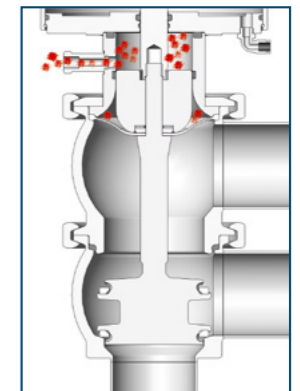

Valve closed

DCX4 diaphragm valve also comes in alcohol barrier and steam level versions.

Contamination from the atmosphere

ONE-PIECE PLUG

The DCX4 divert valves are fitted as standard with a one-piece plug with a floating PFA seal. In its standard version, the one-piece plug is made of 316L / AISI1.4404 stainless steel. Its sturdy design eliminates the risk of breakage and loosening.

A WINNING COMBINATION PFA SEAL AND FLOATING SEAL TECHNOLOGY

The floating PFA (PerFluoroAlcoxy) seal is clipped into the plug housing. Its floating assembly ensures perfect cleanability. Its expansion allows the cleaning fluid to flow over all of its faces. Its elastomer structure also ensures the absence of porosity or crevices, risks of contamination and bacteriological growth, without risk of alteration of taste or appearance of the process fluid in contact with the PFA.

It offers excellent resistance to chemical aggressive products and high temperatures. Its lifetime is longer.

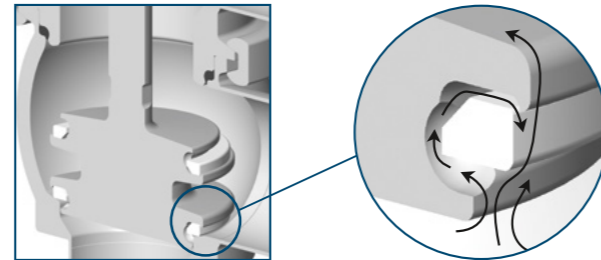

DIFFERENT DESIGN VARIATIONS FOR SIMPLE, FLEXIBLE ADAPTATION TO PROCESS CHANGES

> Elastomer seal for charged or abrasive products

EPDM, FKM or HNBR versions available. Latest-generation elastomers providing excellent chemical resistance within their field of application.

The small area of elastomer in contact with the product increases the service life of the seals and ensures a level of hygiene that is compatible with the sanitary requirements of the processes.

NEW

> PFA DCX4 balanced version

It integrates a fixing system, which avoids the release of the plug, and a partial balancing which limits water hammers while valve operating. Equipped with one-piece plug and floating PFA seal.



> Deformable sealing diaphragm in PTFE (for aseptic applications)

Forming a physical barrier between the inside of the valve and the outside.

Surface area of diaphragm equivalent to that of the plug, helping to balance the pressure.

Optional: alcohol barrier.

Diaphragm service life: 100,000 movements at 90°C.



DRIVE MECHANISM



PNEUMATIC ACTUATOR OR MANUAL DEVICE

Different versions are available to cover a maximum of functions using the same components and facilitating the management of spare parts.

All our actuators are removable. The clamp collars make for easy removal and interchangeability of the

drive mechanisms. The design of our actuators makes maintenance operations easy and quick to perform.

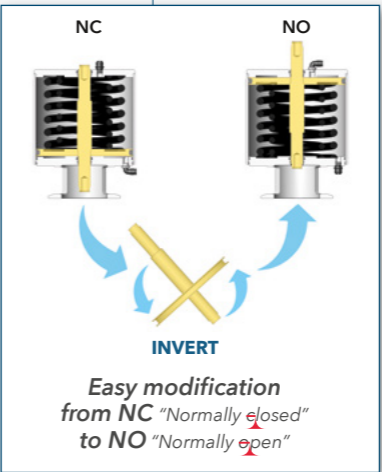
They are generously sized to ensure valve operation with maximum pressure acting on or under the plug (or under high line pressures).

DCX4 NC (Normally Closed)	DCX4 NO (Normally Open)	DCX4 Double-acting
 <p>NC version as standard</p>	 <p>INVERT</p> <p>Easy modification from NC "Normally closed" to NO "Normally open"</p>	 <p>Easily transforms into an NO or double-acting version</p>
DCX4 manual		
<p>Gradual, smooth plug operation.</p> <p>Fitted with a compression spring to prevent vibration-induced loosening.</p> <p>An indicator warns the user in the event of plug stem leakage.</p> 		

We recommend servicing the actuator once every 5 years, under normal operating conditions

DCX4 SINGLE SEALING DIVERT VALVE

DCX4 BALANCED

DCX4 STANDARD

DCX4 DIAPHRAGM VALVE

New Sorio® control top
Available in digital, AS-i (2.0, 2.1 ou 3.0), IO-Link versions. Remote viewing of valve status; 360° led broadcasting. The IO-Link protocol is used to initiate predictive maintenance. Simple remote configuration on PC or from the control top. Cable gland or M12 connection IP 69K. Plastic or stainless-steel cover.

Dismountable pneumatic actuator. Easily transformed into "Normally Open" (NO) - "Normally Closed" (NC) or "Double-Acting" (DA). Actuator sized for single-acting valve operation at high line pressures. Fitted with quick-fitting pneumatic connections for easy maintenance. Common to the entire DCX. Shut-off and divert valves range.

PTFE guide bushings.

Modular seal support plate.

Interchangeable components.

Sturdy one-piece plug meeting sanitary requirements.

PFA floating seal, perfectly cleanable, ensuring perfect leaktightness at high temperature, resistant to cleaning products.

Connection of actuator and shut-off assembly by means of clamp collars for quick intervention.

Volume-machined spherical body with thick walls ensuring excellent resistance to expansion stresses. Ensures the modularity of all options and versions. Configuration in L/L - L/T - T/L - T/T - L/X.

Elastomer variant EPDM, FKM or HNBR. Particularly suitable for process fluids with particles.

Anti-trapping system
Detection (M12 or M18) on single right-angle bracket



Leak indicator providing a visual indication in the event of diaphragm failure.

Deformable PTFE diaphragm. Forming a physical barrier between the inside of the valve and the outside environment. Suitable for greasy and corrosive products (acid base > 3 %).

> Remote status reporting
> 360° light distribution on all planes
> Remote localisation of the valve
> Colours can be defined from the supervision



Example of colours



Maintenance document NM-036 DCX4 divert valve
Maintenance document NM-251 Divert valve variants including diaphragm version



Fitting instructions NI-018 DCX4 divert valve

PRINCIPLE OF DCX4 OPERATION

NORMALLY CLOSED VALVE - NC

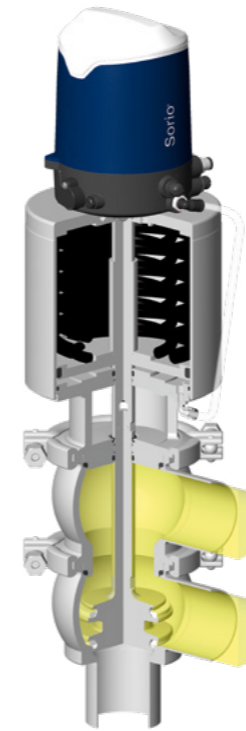

CLOSED POSITION
Upper line flow

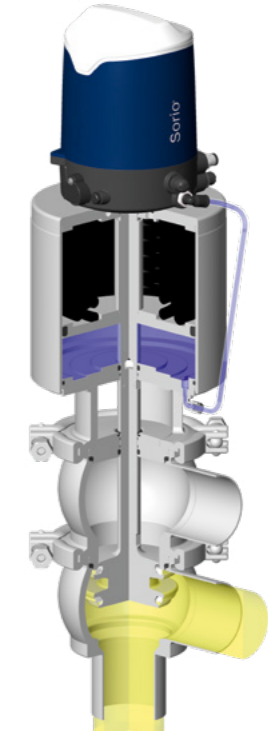

OPEN POSITION
Lower line flow

NORMALLY OPEN VALVE - NO

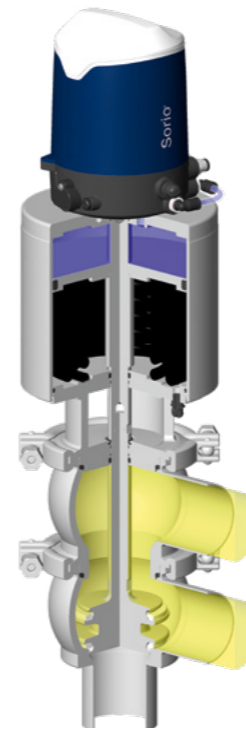

CLOSED POSITION
Upper line flow

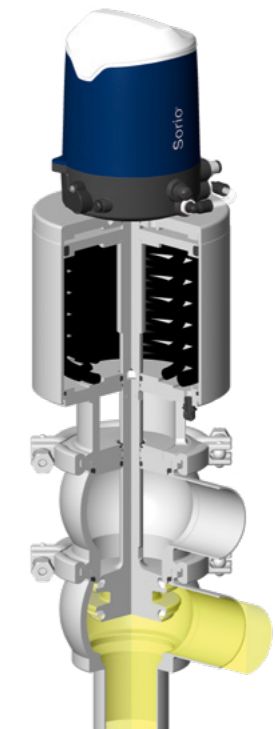

OPEN POSITION
Lower line flow

CHARACTERISTICS

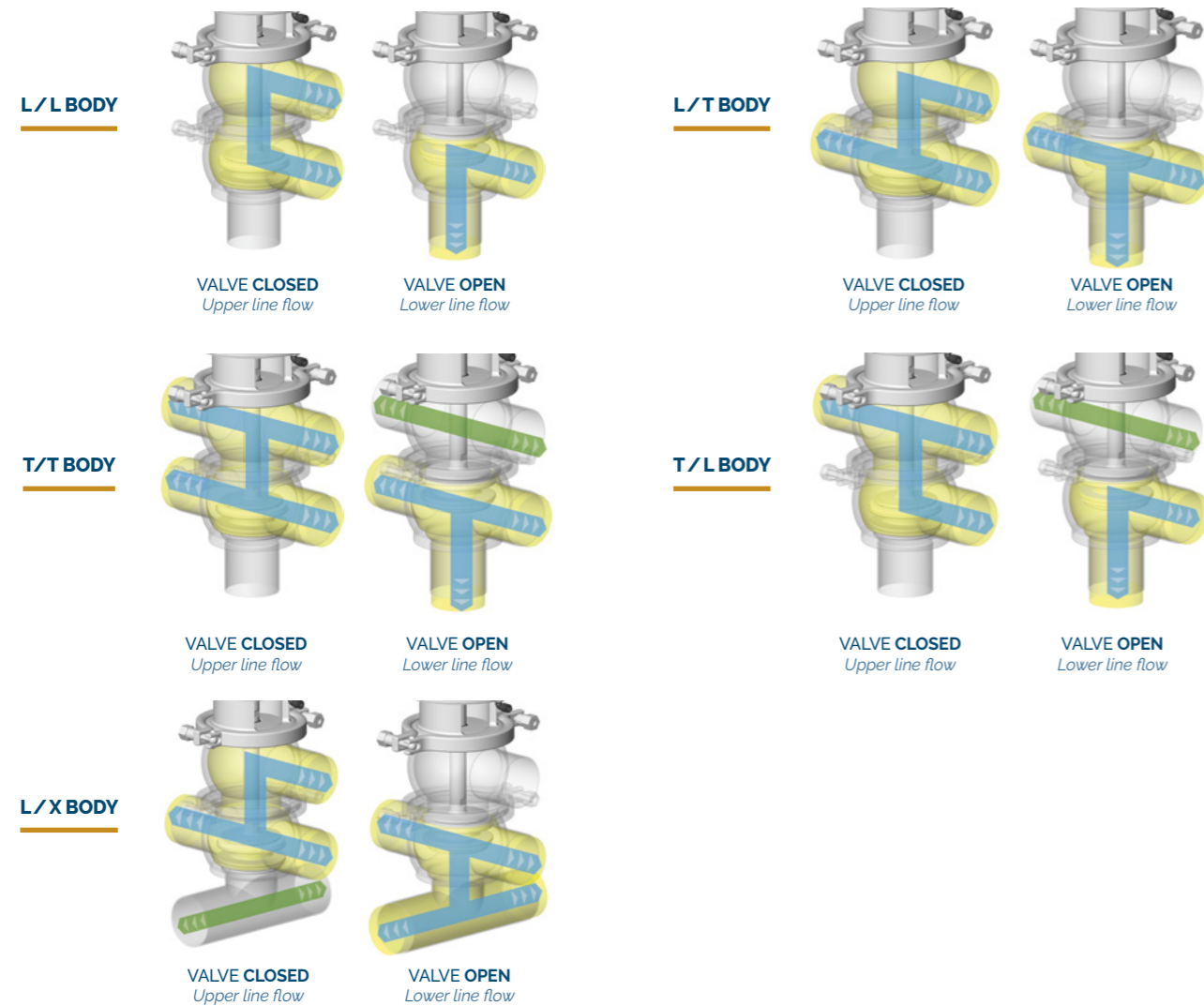

DIMENSIONS

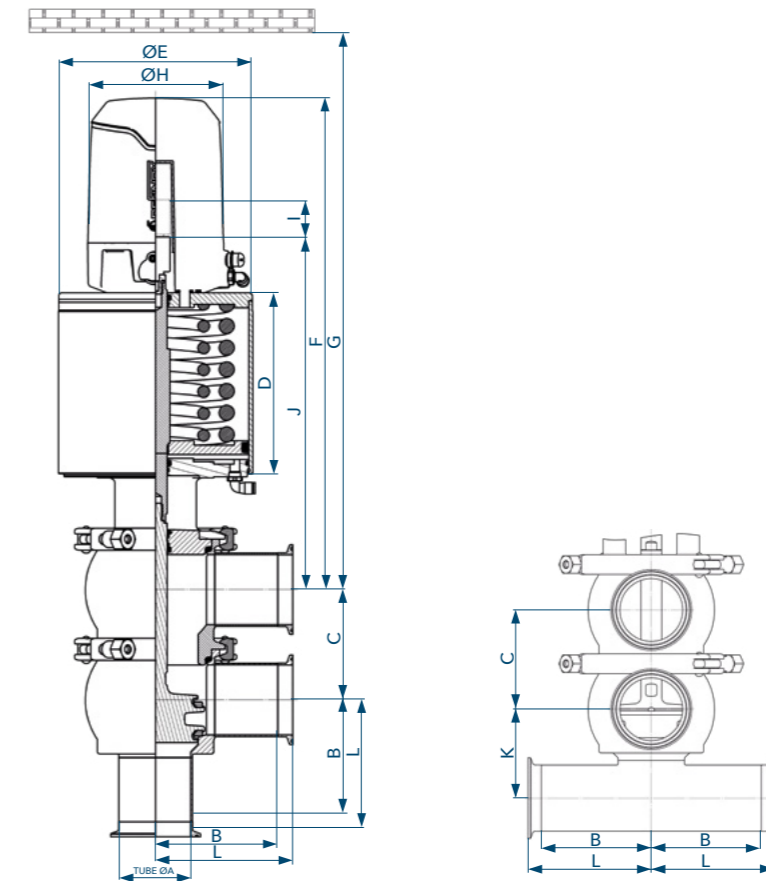

Tube ØA	B	C	D	ØE	F	G with control top	ØH	I DCX4 standard stroke	I DCX4 diaphragm stroke	I DCX4 balanced stroke	J DCX4 standard valve	J DCX4 diaphragm valve	J DCX4 balanced	K	L	Weight in kg without control top DCX4 diaphragm valve	Weight in kg without control top DCX4 diaphragm valve	Weight in kg without control top DCX4 balanced
SMS 22,6/25	55	55	110	89	339	790	117	15	11	15	223	227	225	45	68	5,5	5,5	5,5
SMS 35,6/38	70	70	110	89	346	800	117	20	11	18	225	234	230	55	83	5,5	5,5	5,5
SMS 48,5/51	82	80	123	114	375	830	117	27	17	27	245	266	259	70	95	9	9,5	9,5
SMS 60,3/63,5	105	95	159	167	424	880	117	32	25	34	304	313	308	85	118	20	21	21
SMS 72,9/76,1	110	105	159	167	430	880	117	32	25	34	310	321	315	95	123	21	22	22,5
SMS 100/104	130	150	181	217	481	930	117	36	35	36	365	368	366	125	155	40	41	43
DIN 26/29	55	55	110	89	339	790	117	15	11	14	223	227	225	47	/	5,5	5,5	5,5
DIN 32/35	55	65	110	89	344	800	117	17	11	16	227	233	229	51	/	5,5	5,5	5,5
DIN 38/40	70	70	110	89	346	800	117	20	11	18	225	234	230	55	/	5	5,5	5,5
DIN 50/53	80	80	123	114	375	830	117	27	25	27	245	266	259	71	/	9	9,5	9,5
DIN 66/70	108	100	159	167	427	880	117	31	25	21	307	316	311	93	/	20	21	21
DIN 81/85	115	130	159	167	436	890	117	32	35	32	316	325	319	105	/	28	29	29,5
DIN 100/104	130	150	181	217	481	930	117	36	35	36	365	368	366	125	/	40	41	43
DIN 125/129	160	165	285	270	651	1150	117	55	45	-	517	541	-	155	/	88	96,5	-
DIN 150/154	180	195	285	270	663	1150	117	61	44	-	529	553	-	180	/	92	101	-
US 1" (22,1/25,4)	51	82,5	110	89	339	790	117	15	11	14	222	227	225	45	64	5,5	5,5	5,5
US 1"1/2 (34,8/38,1)	57	82,5	110	89	346	800	117	20	11	18	225	234	230	55	70	5,5	5,5	5,5
US 2" (47,5/50,8)	76	95	123	114	375	830	117	27	17	27	255	266	259	70	89	9	9,5	9,5
US 2"1/2 (60,2/63,5)	76	108	159	167	424	880	117	32	25	21	305	313	308	85	89	20	21	21
US 3" (72,9/76,1)	82	120	159	167	430	880	117	32	25	34	310	321	315	95	95	21	22	22,5
US 4" (97,4/101,6)	130	165	181	217	481	930	117	36	35	36	365	368	366	125	146	40	41	43

> Levels of resistance of elastomers and plastomers

	EPDM	FKM	HNBR	PFA	Diaphragm PTFE
Oil	★	★★	★★	★★	★★
Greasy substances	★	★★	★★	★★	★★
NEP	★★	★★	★	★★	★★
Aggressive chemical products	★	★★	★	★★	★★
Concentrated essential oils and perfume	★	★★	★	★★	★★
Abrasion resistance	★	★	★★	★	★
Low temperature < 5	★★	★	★★	★	★

★★ Very suitable ★ Suitable ★ Not recommended

> Approval of elastomers and plastomers

	EPDM	FKM	HNBR	PFA	Diaphragm PTFE
FDA 21 CFR 177.2660	✓	✓	✓	✓	✓
CE 1935 / 2004	✓	✓	✓	✓	✓
ADI Free	✓	✓	✓	✓	✓
3-A Sanitary Standards	✓ (Class II)	✓ (Class I)		✓	✓
USP Ch.87 and Ch88 Class V	✓				
NSF 51	✓				
ACS		✓		✓	

> Materials

Materials	Body	Plug	Plug seal	O-ring seal	Drive mechanism
	Stainless steel 1.4404 / AISI 316L	Stainless steel 1.4404 / AISI 316L	- Standard PFA version - elastomer (EPDM, FKM or HNBR) - Aseptic PFA version - deformable - PTFE diaphragm	Elastomer (EPDM or FKM)	Stainless steel 1.4301 / AISI 304

Other materials upon request (HSTL C22, URANUS B6, 254 SMO...)

The dimensions are identical for the diaphragm and balanced version and balanced version, except for the I and J dimensions and the weight.

WEIGHT WITH SORIO CONTROL TOP		+ 0,9 kg
For the DN	125 DIN	+ 1,4 kg
	150 DIN	

TECHNICAL DATA

> Actuator air supply*

min 4,5 bar
max 7 bar

*Pressure with direct control top supply

> Pressure (bar)

	PFA	ELASTO	DIAPHRAGM
Maximum operating pressure	8	8	6

> Temperature (°C)*

	PFA/EPDM	PFA/FKM	PFA/HNBR	ELASTO/EPDM	ELASTO/HNBR	DIAPHRAGM/PFA
Min. static temperature	-5	5	-5	-5	120	5
Max. static temperature	120	120	120	120	120	140
Min. dynamic temperature	-5	5	-5	-5	120	5
Max. dynamic temperature	95	95	95	120	120	110
Steam flash (20 min. at max. temperature)	140°C	140°C	120°C	140°C	120°C	140°C

* For pressure of 5 bar

> Temperature differential between the upper channel and the lower channel: max. 120°C

> Temperature / Pressure ratio for PFA seal

> Vacuum retention: 0.9 bar



DCX4 particle passage closed valve

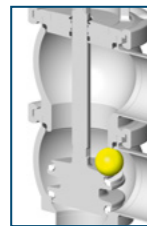

DCX4 PFA particle passage open valve

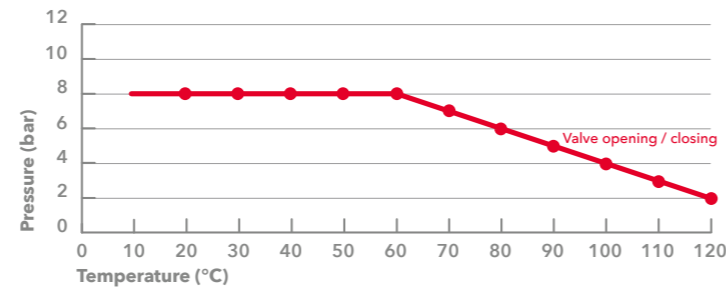

	SMS	UNIT	25		38		51		63		76		104									
			US	1"		1 1/2"	2"	2 1/2"	3"	4"												
DIN 11850 RANGE 2			25	32	40	50	65	85	100	125	150											
Ø particle K standard DCX4	Upper line flow	mm	9,5	9,5	9,5	9,5	9,5	13,5	13,5	13,5	26,5	26,5	26,5	26,5	30	30	49	55				
	Lower line flow	mm	10	10	10	10	13	13	16	21	21	21	26,5	26,5	25,5	27,5	27,5	26,5	30	30	49	55
Ø particle K diaphragm DCX4	Upper line flow	mm	6,5	6,5	6,5	6,5	6,5	6,5	6,5	11	11	11	19,5	19,5	19,5	20,5	20,5	20	29	29	39	39
	Lower line flow	mm	6,5	6,5	6,5	7	6,5	6,5	6,5	11	11	11	19,5	19,5	19,5	20,5	20,5	19,5	29	29	39	39
Ø particle K balanced DCX4	Upper line flow	mm	5	5	-	-	5	5	-	6,5	6,5	6,5	15	15	-	17,5	17,5	26	30	30	-	-
	Lower line flow	mm	10	10	-	-	13	13	-	31	31	31	15	15	-	27,5	27,5	26,5	30	30	-	-
Body wall thickness	mm		5	5	5	5	5	5	5	6	6	6	7	7	7	7	7	7	7	7	9	9

Air consumption (volume at atmospheric pressure)	Standard DCX4 divert valve	NI	0,25				0,5				1,25				2,25		4		4	
	Diaphragm DCX4 divert valve	NI	0,125				0,25				0,875				2		2,5		2,5	

Operating time (with Sorio top unit) Actuator air : 6 bar Operating pressure: 6 bar Circulation speed 2.5 m/s	Valve opening	sec	0,5	0,5	0,5	0,5	0,5	0,5	0,5	1	1	1	1	1,5	1,5	1,5	1,5	2,6	2,6	2,6	11,4	11,4
	Valve closure	sec	0,7	0,7	0,7	0,7	0,7	0,7	0,7	1,5	1,5	1,5	1,5	3,3	3,3	3,3	3,3	3,3	6,5	6,5	15,5	15,5
	Quick drain	sec	<0,2	<0,2	<0,2	<0,2	<0,2	<0,2	<0,2	<0,2	1	1	1	1	1,5	1,5	1,5	1,5	1,5	2,5	2,5	6

The operating conditions are given for information only. Combinations of extreme operating conditions may sometimes be inappropriate. In these cases, it is strongly advised to obtain advice from us.

LOSS OF PRESSURE DCX4 DIVERT VALVES DN25 TO DN51

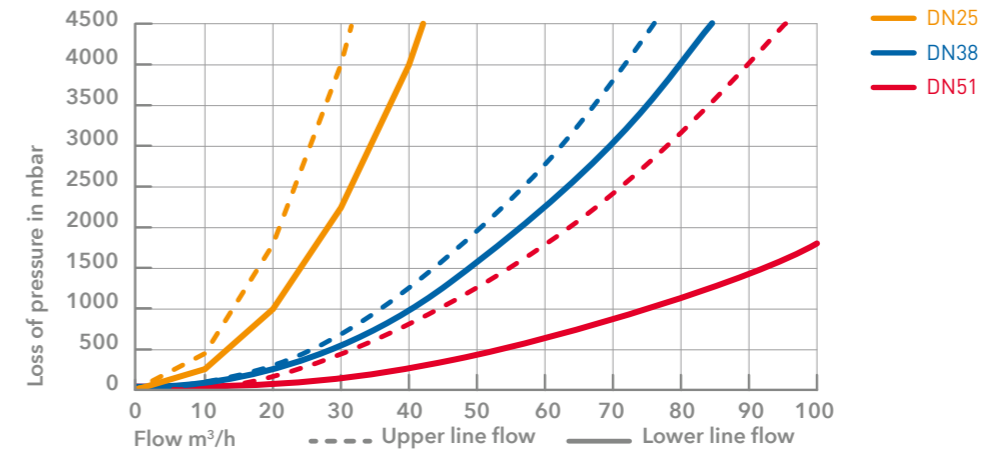

LOSS OF PRESSURE DCX4 DIVERT VALVES DN36 TO DN150

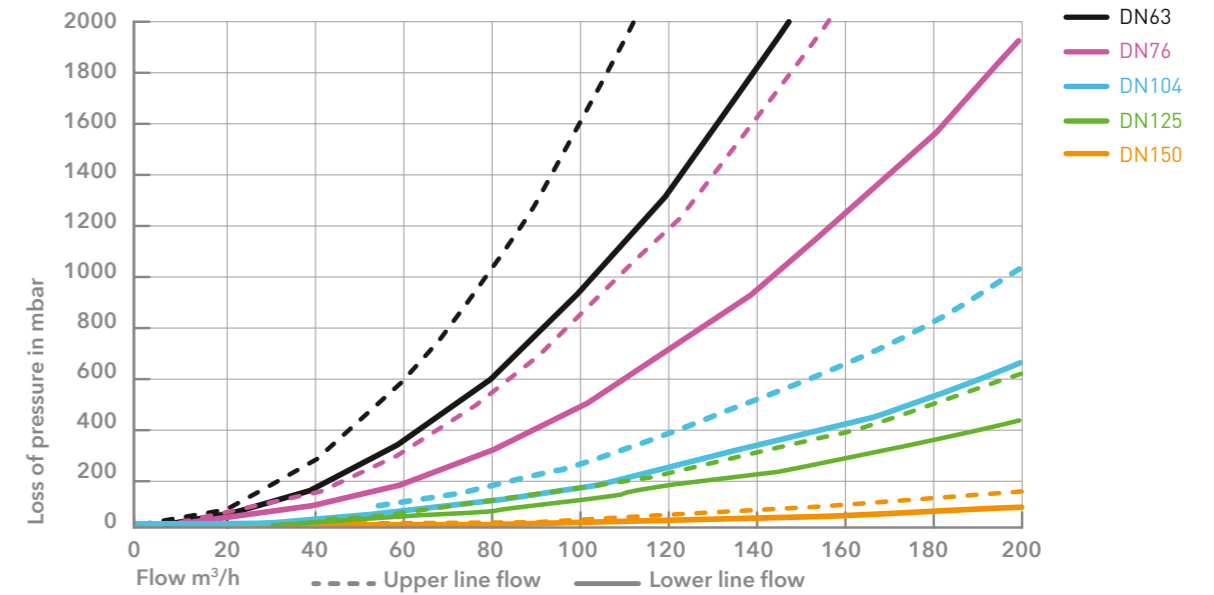

SMS	25			38		51		63		76		104		
US	1"			1 1/2"		2"		2 1/2"		3"		4"		
DIN 11850 RANGE 2	25	32	40	50	65	80	100	125	150					
Loss of pressure Kv Lower line flow	20	23	35	40	42	74	77	101	115	144	164	250	308	708
Loss of pressure Kv Upper line flow	15	18	30	36	38	45	48	80	94	111	131	198	256	539
Loss of pressure Cv Lower line flow	23	27	41	46	49	86	89	117	133	167	190	290	357	821
Loss of pressure Cv Upper line flow	17	21	35	42	44	52	56	93	109	129	152	230	297	625

> Tribofinishing

Surface condition maximizing external and internal cleanability of the valves. For heavy-duty applications, erasure of external and internal welds upon request.

Surface condition	External	1.2 µm (150 grit)
	Internal	0.8 µm (180 grit)

(Other surface finishing on request).

FRACTIONAL DIVERT VALVE DCX4 FRACT

These small, single-seated divert valves are characterised by high sealing pressures. They are used in the Starmotion pigging stations and Starwheel injection systems, among others.



AUTOMATIC FRACTIONAL DIVERT VALVE

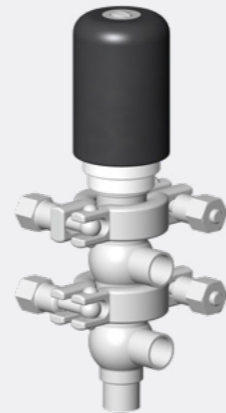

MANUAL FRACTIONAL DIVERT VALVE

DCX4 AUTOMATIC FRACTIONAL



Compact, removable pneumatic actuator, easily convertible NO (Normally Open), NC (Normally Closed) or DA (Double Acting).

Adjustable actuator for pressure adjustment in valve assembly.

One-piece, compact body. L/L, T/L or L/T configuration.

PEEK valve, as standard material inert to chemicals. EPDM, FKM or FFKM sealing.

Easy maintenance through clamped assembly of sub-assemblies.



Stainless steel damper variant, EPDM, FKM or FFKM elastomer seal.

PFA variant, sealing FFKM.

DIMENSIONS

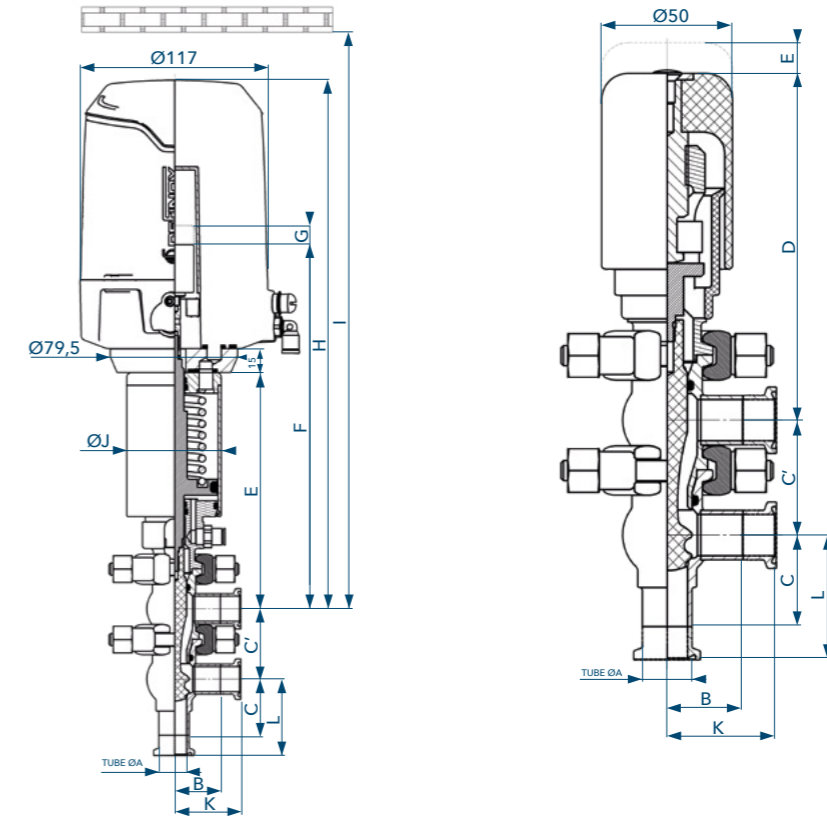

TUBE Ø A	B	C	C'	D	E	F	STROKE G	H	I	ØJ	K	L	WEIGHT IN KG DCX4 FRAC Manual	Automatic
US 1/2" (12,7 x 1,65)	27,5	30	44	128	145	225	9	328	600	59	40	42,5	1,2	2
US 3/4" (19,05 x 1,65)	29	35	44	131	148	227	9	331	600	59	41,5	47,5	1,2	2
US 1" (25,4 x 1,65)	33,5	40	55,5	131	163	243	12	346	650	71	46	52,5	1,8	3,2

WEIGHT WITH SORIO CONTROL TOP + 1,3 kg

OPERATING CONDITIONS

MANUAL AND AUTOMATIC FRACTIONAL DCX4 DIVERT VALVE

DN	Maximum sealing pressure	Maximum operating pressure	Resistance to vacuum	Temperatur			Passage of particle		
				Max	Min	Delta	2 mm	3,5 mm	6 mm
1/2"	18 bar (1800 kPa)	16 bar (1600 kPa)	-0,9 bar	140°C	-5°C	120°C	2 mm	3,5 mm	6 mm
3/4"	18 bar (1800 kPa)	16 bar (1600 kPa)	-0,9 bar	140°C	-5°C	120°C	3,5 mm	6 mm	7 mm
1"	18 bar (1800 kPa)	16 bar (1600 kPa)	-0,9 bar	140°C	-5°C	120°C	6 mm	10 mm	10 mm

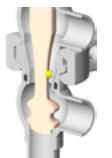

AUTOMATIC FRACTIONAL DCX4 DIVERT VALVE

DN	Operating time	Air consumption	Actuator supply pressure		Loss of pressure (Kv)	Loss of pressure(Cv)
			Max	Min		
1/2"	0,5 s	0,3 NI	8 bar (800 kPa)	4,5 bar (450 kPa)	3,2	3,71
3/4"	0,5 s	0,3 NI	8 bar (800 kPa)	4,5 bar (450 kPa)	10,7	12,4
1"	0,75 s	0,5 NI	8 bar (800 kPa)	4,5 bar (450 kPa)	21	24,36

LOSS OF PRESSURE DCX4 DIVERT VALVES

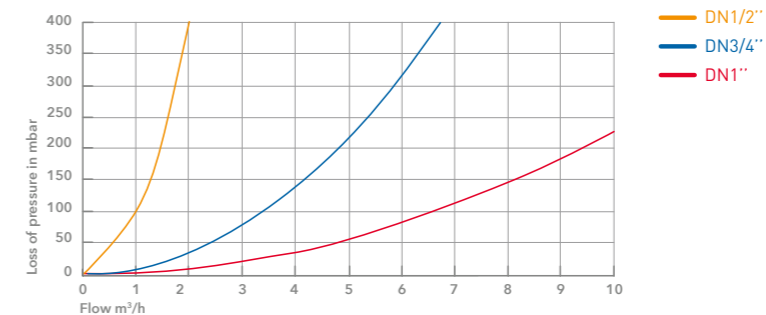

REVERSE DCX4 DIVERT VALVE

To complete the range of isolation valves and offer a greater combination of body configurations, the DCX4 divert valve is available in a REVERSE version. This valve manages any direction of flow, ensuring optimal sealing performance. It can be easily integrated into your existing lines.

The operating conditions are identical to the standard DCX4 version.



REVERSE DCX4 DIVERT VALVE
L/L/L CONFIGURATION

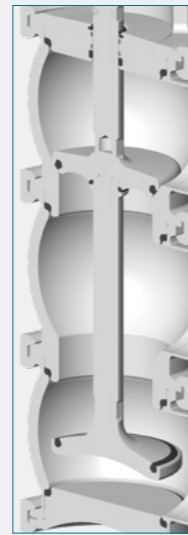

REVERSE DCX4, ONLY AVAILABLE IN ELASTOMER
VERSION EPDM OU FKM.

OPERATING PRINCIPLE REVERSE DCX4

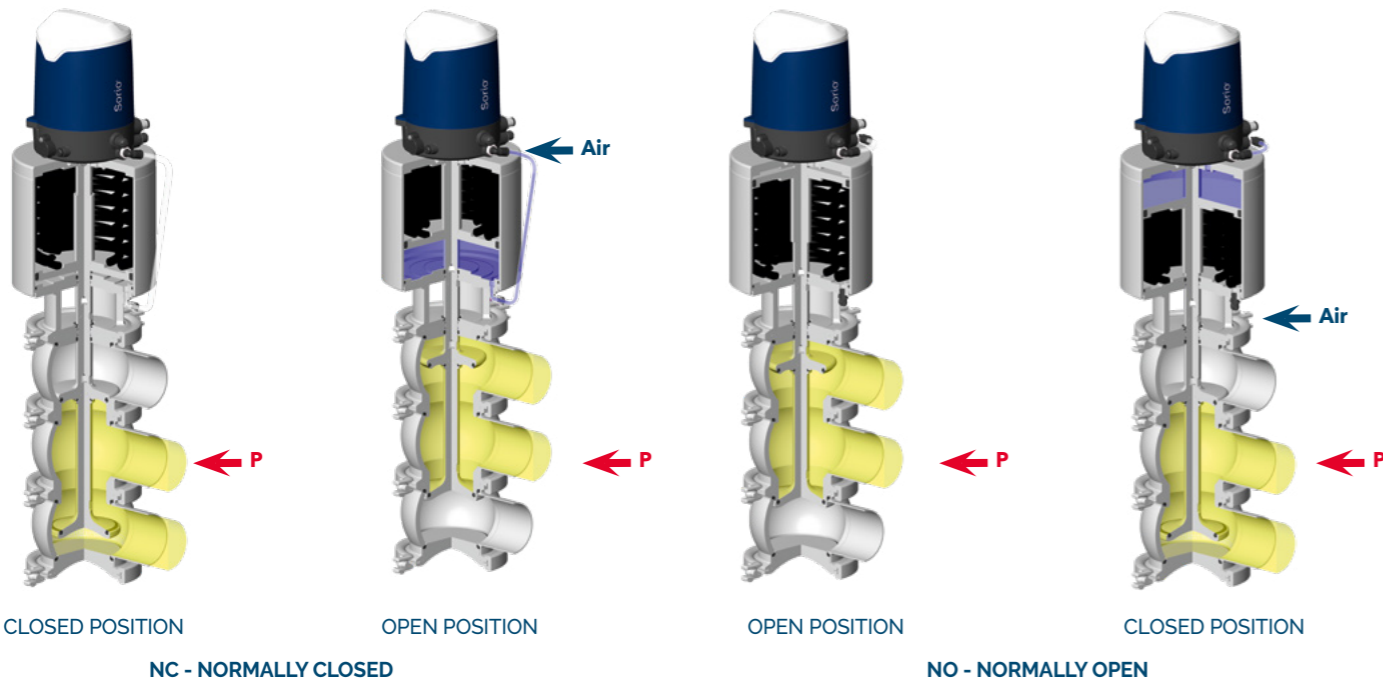

DIMENSIONS

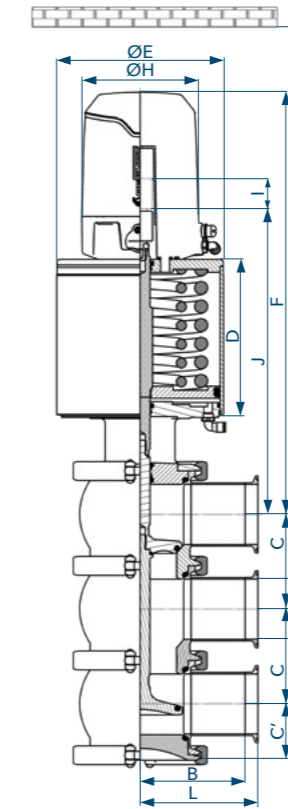

TUBE Ø A	B	C	C'	D	Ø E	F	G with control top	Ø H	I Stroke	J	L	Weight in Kg with control top DCX4 Reverse
SMS 22,6/25	55	55	37	110	89	339	790	117	14	218	68	8
SMS 35,6/38	70	70	46	110	89	346	800	117	20	224	83	8
SMS 48,5/51	82	80	48	123	114	375	830	117	28	254	95	12,5
SMS 60,3/63,5	105	95	57	159	167	424	880	117	33	304	118	26
SMS 72,9/76,1	110	105	61	159	167	430	880	117	34	310	123	27
SMS 100/104	130	150	92	181	217	481	930	117	39	362	155	63
DIN 26/29	55	55	37	110	89	339	790	117	14	218	/	8
DIN 32/35	55	65	42	110	89	344	800	117	17	226	/	8
DIN 38/40	70	70	46	110	89	346	800	117	20	224	/	8
DIN 50/53	80	80	48	123	114	375	830	117	28	254	/	12,5
DIN 66/70	108	100	59	159	167	427	880	117	32	308	/	26
DIN 81/85	115	130	80	159	167	436	890	117	34	316	/	28,5
DIN 100/104	130	150	92	181	217	481	930	117	39	362	/	63
DIN 125/129	160	165	93	285	270	651	1150	117	75	511	/	110
DIN 150/154	180	195	110	285	270	663	1150	117	74	523	/	116
US 1" (22,1/25,4)	51	82,5	37	110	89	339	790	117	14	218	64	8
US 1"1/2 (34,8/38,1)	57	82,5	46	110	89	346	800	117	20	224	70	8
US 2" (47,5/50,8)	76	95	48	123	114	375	830	117	28	255	89	12,5
US 2"1/2 (60,2/63,5)	76	108	57	159	167	424	880	117	33	303	89	26
US 3" (72,9/76,1)	82	120	61	159	167	430	880	117	34	310	95	27
US 4" (97,4/101,6)	130	165	92	181	217	481	930	117	39	362	146	65

WEIGHT WITH SORIO CONTROL TOP		+ 0,9 kg
Diameter	125 DIN	+ 1,4 kg
	150 DIN	

CUSTOMER SERVICE

PERSONALIZED SUPPORT

Our customer services offer training and maintenance services and assist you with the management of your spare parts.



AUTONOMY OF INTERVENTION ON YOUR INSTALLED VALVES FLEET

With theoretical and practical training adapted to your needs, on site or at Definox*.

*Definox is Qualiopi certified

SAFE OPERATIONS

Maintenance can be carried out with standard tools.

For greater efficiency and safety during maintenance, we offer a dismantling press and a tool case.

MAINTENANCE ADVICE

You can find all our tips for working on DCX4 valves in the maintenance and installation manuals. Before working on our valves, it is recommended to use the appropriate tooling kits.

 Follow the step-by-step disassembly and reassembly of DCX4 valves on the maintenance video, available on YouTube and [definox.com](https://www.definox.com)

PERSONALISED MONITORING PROGRAMME FOR THE VALVES FLEET

Our teams of specialised technicians operate in France and abroad for the maintenance of valves.

Our actuators are guaranteed for 5 years from delivery under normal operating conditions with a dry filtered air supply according to DIN/ISO 8573-1.

We recommend replacing the wearing parts of the actuator at the end of the warranty period and every 5 years thereafter.

WARRANTY ON ORIGINAL SPARE PARTS

- Designed and selected specifically for DEFINOX products.
- Interchangeable parts for optimised spare parts stock management.
- The valve design reduces the number of seals.



DOWNLOAD, SCAN, BROWSE...

The augmented reality developed by DEFINOX for more services.

- Immediate identification of the valve and spare parts.
- Saves time on valve fleet management.
- Reduced risk of errors.
- Immediate access to documentation.
- Individualized monitoring of the valve with the service book function.



THE SERVICE BOOK

Saves you time in managing your valve fleet and allows you to monitor each valve individually.

- > **Monitoring of preventive and corrective maintenance.**
- > **Reminder of the next maintenance dates.**
- > **Adding intervention reports, notes, photos and equipment identification tags.**



MOBILE APPLICATION,
FREE TO DOWNLOAD AND
ACCESSIBLE FROM YOUR SMARTPHONE



DEFINOX, SPECIALIST FOR OVER 50 YEARS

Specialist in the transfer of liquids for more than 50 years, DEFINOX designs and manufactures process valves and customized equipment in stainless-steel for the food, cosmetic and fine chemicals industries.



70  COUNTRIES

60 000  EQUIPMENT AND VALVES SOLD PER YEAR

150  EMPLOYEES

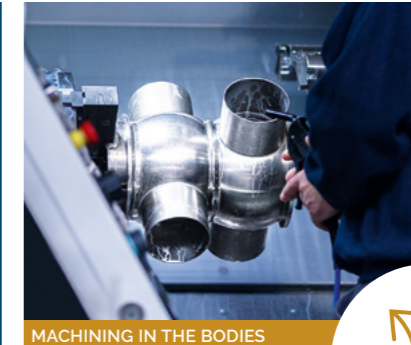

FIELDS OF APPLICATION

DEFINOX valves can be used on liquids or semi-liquids, more or less viscous, without risk of denaturing the manufactured product.

- **Food:** dairy products, jam, chocolate...
- **Cosmetics / Perfume**
- **Hygiene products:** toothpaste, shampoo, shower gel...
- **Household products:** laundry, detergent...
- **Animal food**
- **Paint**
- **Lithium battery**



DEFINOX, FLEXIBILITY AND PERFORMANCE

The machining, turning and welding techniques selected by DEFINOX for the production of valves, pigging solutions and personalized equipment give strategic components in contact with the fluid a high level of finish and quality and in accordance with process requirements.

Mass-machines of the bodies is the guarantee of manufacturing parts without retention zones. This process provides great resistance to mechanical and thermal deformation. The spherical shape of the bodies promotes optimum fluid flow and a reduction in pressure losses.

Milling and turning operations offer great flexibility to adapt the outlet pipes. Many configurations are thus made possible.

The internal polishing (Ra = 0.8 µm or 180 grit) contributes to a good in-line cleanability. This is the assurance of a finish that complies with health requirements. A passivation operation reinforces the corrosion resistance.

The quality of the welds (made by TIG certified welders) meets health standards and requirements. The welds guarantee good geometry and resistance of the mechanically welded assemblies.

DEFINOX is committed to a Lean Manufacturing approach and continuous improvement. Our industrial and organizational choices optimize our production flows and provide the flexibility necessary to produce specific valves or specific equipment according to customer needs.



IMMERSE YOURSELF IN OUR WORKSHOPS





ENGINEERING DEPARTMENT

Our engineering department provides knowledge in IO-Link technology associated with process valves and liquid transfer.

It advises and supports your approach to implement predictive valve maintenance.

A renowned French brand, DEFINOX specializes in the design and production of units that meet specific customer specifications.
(valve manifolds, pigging solutions, injection systems ...).

The valves and equipment meet the standards of the regulations in force applicable to hygienic processes and the most severe constraints in terms of cleanability.

[definox.com](https://www.definox.com)

AND FOLLOW US ON:



DEFINOX SAS

3 rue des Papetiers - ZAC Tabari Sud
44190 CLISSON - FRANCE

Tél. +33 (0)2 28 03 98 50 - info@definox.com

DEFINOX Beijing

Stainless Steel Equipment Ltd - No 18 East Road
An Ning Zhuang Qinghe - Beijing Haidian District
BEIJING 100085 - CHINA

Tél. +86 10-6293-4909 - msn@definox.com.cn

DEFINOX Inc

16720 W. Victor Road - New Berlin
53151 WISCONSIN - USA

Tél. +1 262-797-5730 - sales@definox-usa.com