

SINGLE SEALING SHUT-OFF VALVE

DCX3



TECHNICAL ADVANTAGES

DCX3

SINGLE SEALING SHUT-OFF VALVES

The DEFINOX DCX3 shut-off valve has been designed to efficiently respond to market requirements, both from a cleanability and an operational point of view.

Its different configurations incorporate the cutoff, tapoff and orientation functions.

With their simple design, which has been tried and tested for many years, the floating PFA seal shut-off valves have successfully passed the EHEDG and 3A tests, guaranteeing their hygienic design, which is particularly suitable for the food-processing industries.

The modular design facilitates the component interchangeability and incorporates a wide range of options and variants. DCX range shut-off valves can thus cover a large range of applications and process configurations, while at the same time meeting market expectations and requirements.

They are fitted as standard with a PFA floating seal plug ensuring excellent valve cleaning.



PRODUCT BENEFITS DCX3

- + **From DN 25 to DN 150** (certain variants up to DN 250), SMS-DIN and US versions.
- + **PFA floating seal, perfectly cleanable**, ensuring perfect leaktightness at high temperature and good resistance to chemical products.
- + **Spherical body with thick walls** ensuring excellent resistance to expansion stresses and optimum cleanability.
- + **Can be used in numerous applications and configurations**
 - Various sealing solutions (different grades of latest generation elastomer – PFA – metal-on-metal).
 - Different body configuration options: L - T - X - half X.
 - Numerous end connections possible: SMS - DIN - Clamp.
- + **Removable and easily transformable pneumatic actuator: NO-NC-Double acting.**
- + **Easy and quick maintenance** thanks to the clamp subassembly assembly.

DEFORMABLE PTFE DIAPHRAGM BARRIER EFFECT



DCX3 standard equipped with a stainless-steel valve with floating PFA seal

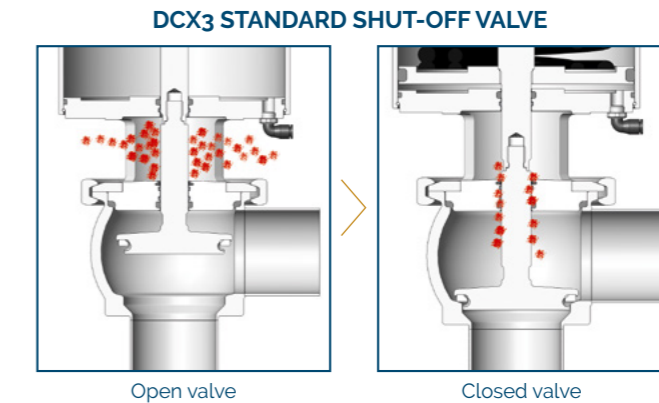

DCX3 diaphragm equipped with a stainless-steel valve with floating PFA seal and a deformable PTFE diaphragm

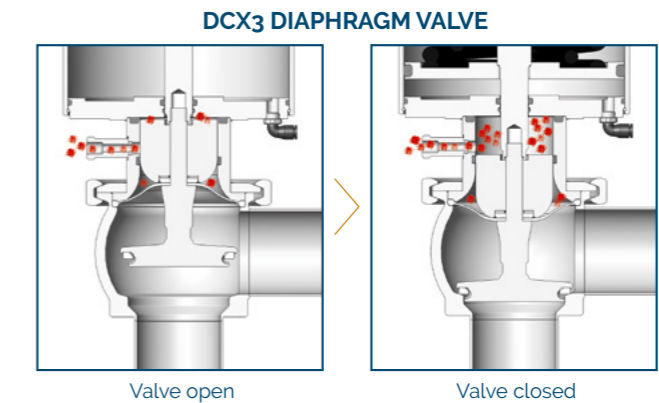

The DCX3 valve is also available in alcohol barrier and aseptic guide bearing versions.

ONE-PIECE PLUG

The DCX3 shut-off valves are fitted as standard with a one-piece plug with a floating PFA seal. In its standard version, the one-piece plug is made of 316L / AISI1.4404 stainless steel. Its sturdy design eliminates the risk of breakage and loosening.

A WINNING COMBINATION PFA SEAL AND FLOATING SEAL TECHNOLOGY

The floating PFA (PerFluoroAlcoxy) seal is clipped into the plug housing. Its floating assembly ensures perfect cleanability. Its expansion allows the cleaning fluid to flow over all of its faces. Its plastomer structure also ensures the absence of porosity or crevices, risks of contamination and bacteriological growth, without risk of alteration of taste or appearance of the process fluid in contact with the PFA.

It offers excellent resistance to chemical aggressive products and high temperatures. Its lifetime is longer.

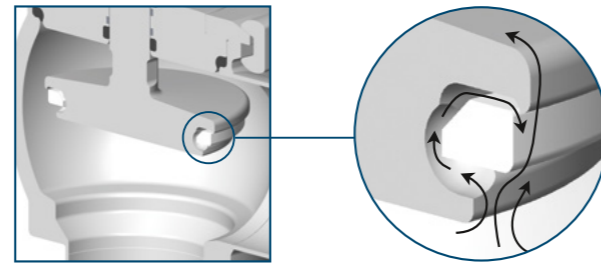

DIFFERENT DESIGN VARIATIONS FOR SIMPLE, FLEXIBLE ADAPTATION TO PROCESS CHANGES

> Elastomer seal for charged or abrasive products

EPDM or FKM versions available. Latest-generation elastomers providing excellent chemical resistance within their field of application.

The small area of elastomer in contact with the product increases the service life of the seals and ensures a level of hygiene that is compatible with the sanitary requirements of the processes.

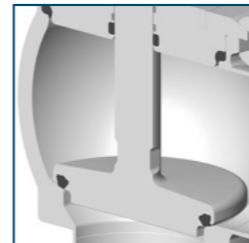

> Deformable sealing diaphragm in PTFE (for aseptic applications)

Forming a physical barrier between the inside of the valve and the outside.

Surface area of diaphragm equivalent to that of the plug, helping to balance the pressure.

Optional: alcohol barrier.

Diaphragm service life: **100,000 movements at 90°C.**

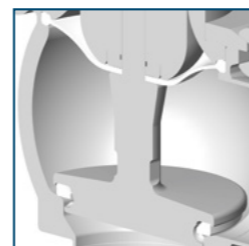

PEEK plug without seal for steam and chemical product applications

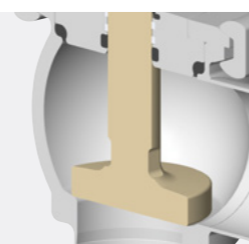

DRIVE MECHANISM



PNEUMATIC ACTUATOR OR MANUAL DEVICE

Different versions are available to cover a maximum of functions using the same components and facilitating the management of spare parts.

All our actuators are removable. The clamp collars make for easy removal and interchangeability of the

drive mechanisms. The design of our actuators makes maintenance operations easy and quick to perform.

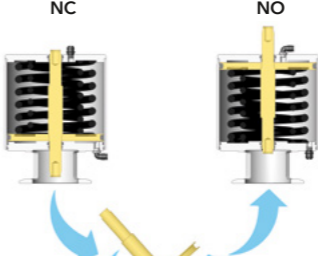
They are generously sized to ensure valve operation with maximum pressure acting on or under the plug (or under high line pressures).

DCX3 NC (Normally Closed)	DCX3 NO (Normally Open)	DCX3 Double-acting
 <p>NC version as standard</p>	 <p>INVERT Easy modification from NC "Normally Closed" to NO "Normally Open" No additional parts required</p>	 <p>Easily transforms into an NO or double-acting version</p>
DCX3 long stroke Liquid flow area exceeds the nominal cross-sectional area of the pipe. Suitable for fibrous or fragile products. Provides maximum plug clearance, thus avoiding fluid break-up or trapping fibers in suspension. Tank bottom version available.		DCX3 manual Gradual, smooth plug operation. Fitted with a compression spring to prevent vibration-induced loosening. An indicator warns the user in the event of plug stem leakage.
DCX3 / 3 functions valve Enables a valve to be set under the plug, as well as a maximum valve "hold closed" pressure value.		DCX3 mechanical adjustment Allows accurate adjustment of the calibration value. Option of sealing the pre-set pressure value.

We recommend servicing the actuator once every 5 years, under normal operating conditions.

DCX3 SINGLE SEALING SHUT-OFF VALVE

DCX3 STANDARD

Anti-trapping system Detection (M12 or M18) on single right-angle bracket



New Sorio® control top
Available in digital, AS-i (2.0, 2.1 ou 3.0), IO-Link versions. Remote viewing of valve status; 360° led broadcasting. The IO-Link protocol is used to initiate predictive maintenance. IP 69K Simple remote configuration on PC or from the control top. Plastic or stainless-steel cover.

DCX3 DIAPHRAGM VALVE

- > Remote status reporting
- > 360° light distribution on all planes
- > Remote localisation of the valve
- > Colours can be defined from the supervision



Dismountable pneumatic actuator. Easily transformed into "Normally Open" (NO) - "Normally Closed" (NC) or "Double-Acting" (DA). Actuator sized for single-acting valve operation at high line pressures. Fitted with quick-fitting pneumatic connections for easy maintenance. Common to the entire DCX Shut-off valve range.

Long stroke option for maximum plug clearance.

PTFE guide bushings.

Modular seal support plate.

Interchangeable components.

Leak indicator providing a visual indication in the event of diaphragm failure.

Deformable PTFE diaphragm. Forming a physical barrier between the inside of the valve and the outside environment. Suitable for greasy and corrosive products (acid base > 3 %).

Elastomer variant EPDM or FKM. Particularly suitable for process fluids with particles

Sturdy one-piece plug meeting sanitary requirements.

PFA floating seal, perfectly cleanable, ensuring perfect leaktightness at high temperature, resistant to cleaning products.

Connection of actuator and shut-off assembly by means of clamp collars for quick intervention.

Volume-machined spherical body with thick walls ensuring excellent resistance to expansion stresses. Ensures the modularity of all options and versions L-T-X - half-X configuration.

Optional alcohol barrier (up to DN 250 - 10")



Maintenance document NM-036 DCX3 shut-off valve
Maintenance document NM-251 Shut-off valve variants including diaphragm version



Fitting instructions NI-018 DCX3 shut-off valve

PRINCIPLE OF DCX3 OPERATION

NORMALLY CLOSED VALVE - NC

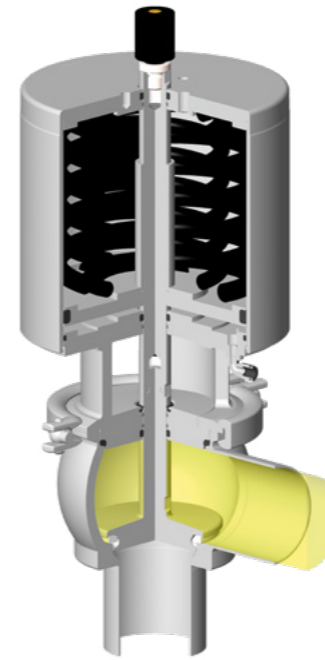

CLOSED POSITION

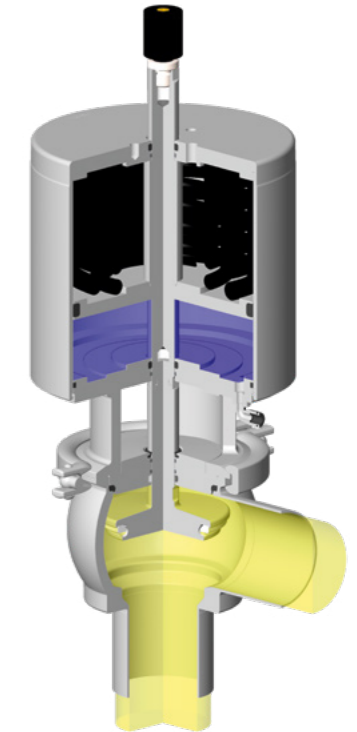

OPEN POSITION

NORMALLY OPEN VALVE - NO

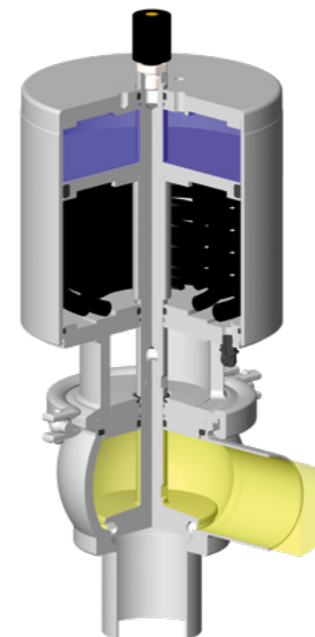

CLOSED POSITION

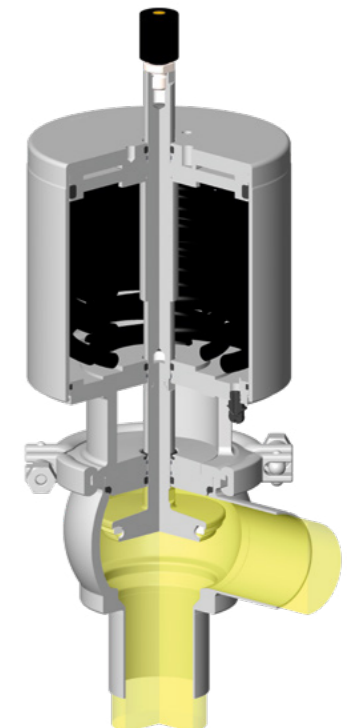

OPEN POSITION

CHARACTERISTICS

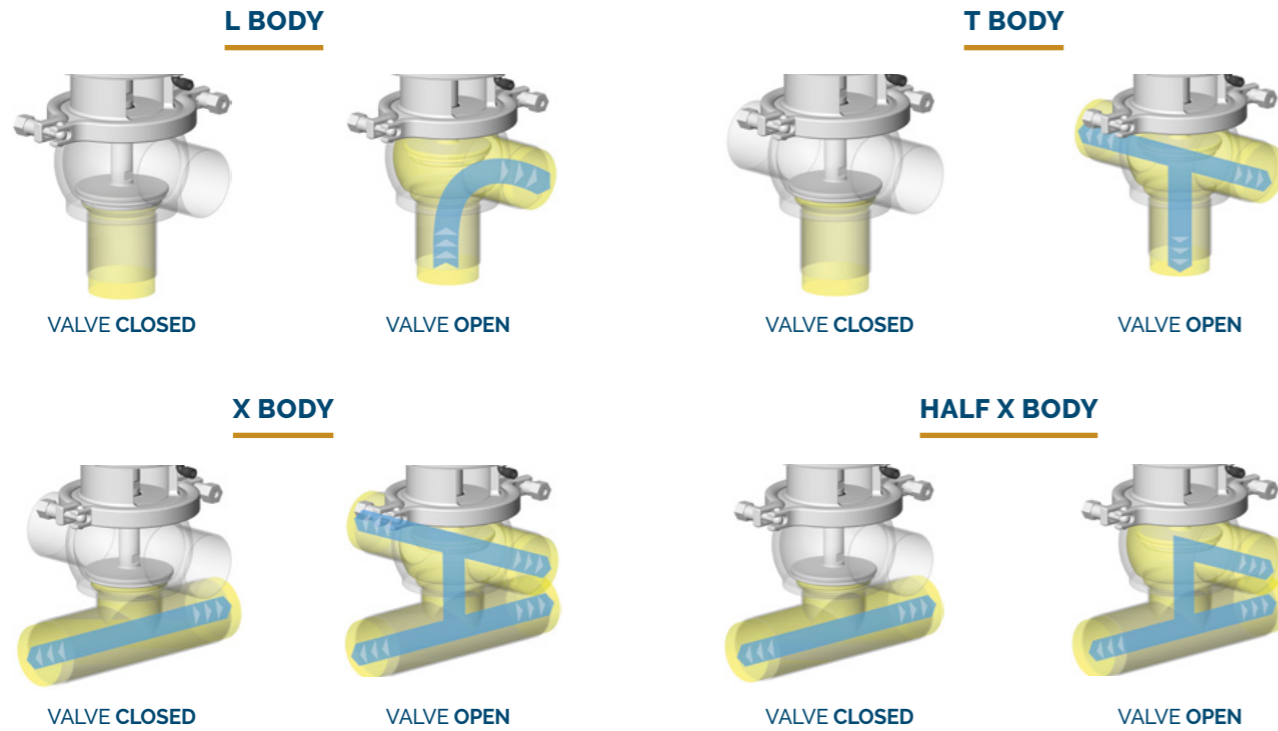

> Levels of resistance of elastomers and plastomers

	EPDM	FKM	PFA	PTFE
Oil	★	★★	★★	★★
Greasy substances	★	★★	★★	★★
NEP	★★	★★	★★	★★
Aggressive chemical products	★	★★	★★	★★
Concentrated essential oils and perfums	★	★★	★★	★★
Abrasion resistance	★	★	★	★
Low temperature < 5	★★	★	★	★

★★ Very suitable
 ★ Suitable
 ★ Not recommended

> Approval of elastomers and plastomers

	EPDM	FKM	PFA	PTFE
FDA 21 CFR 177.2660	✓	✓	✓	✓
CE 1935 / 2004	✓	✓	✓	✓
ADI Free	✓	✓	✓	✓
3-A Sanitary Standards	✓ (Class II)	✓ (Class I)	✓	✓
USP Ch.87 and Ch88 Class V	✓			
NSF 51	✓			
ACS	✓		✓	

> Materials

Materials	Body	Plug seal	O-ring seal	Drive mechanism
	Stainless steel 1.4404 / AISI 316L	Stainless steel 1.4404 / AISI 316L or PEEK	- Standard PFA version - elastomer (EPDM or FKM) - Aseptic PFA version - deformable PTFE diaphragm	Elastomer (EPDM or FKM)
				Stainless steel 1.4301 / AISI 304

Other materials upon request (HSTL C22 URANUS B6 254 SMO,...)

DIMENSIONS

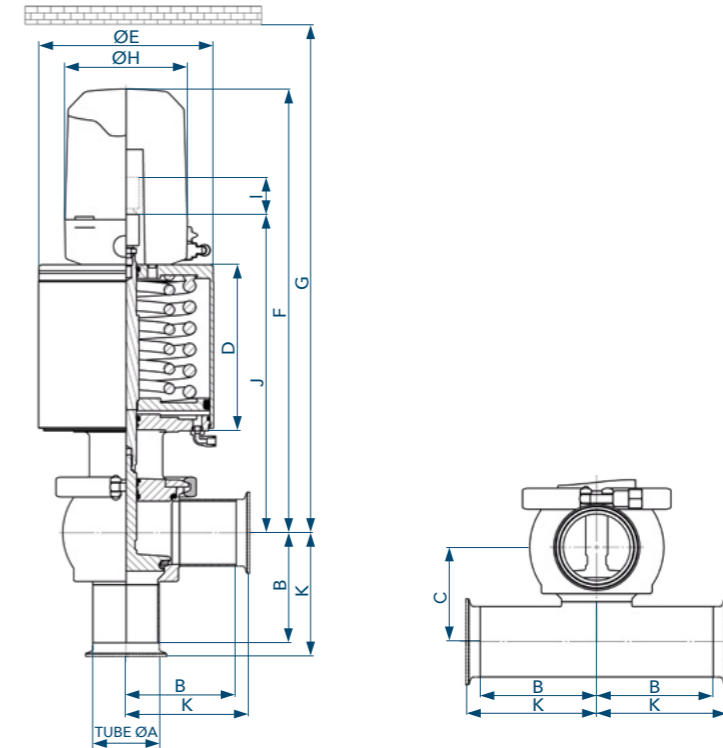

Tube ØA	B	C	D	ØE	F	G with control top	ØH	I DCX3 standard stroke	I* DCX3 diaphragm stroke	J DCX3 standard valve	J* DCX3 diaphragm valve	K	Weight in kg without control top	Weight in kg without control top DCX3 diaphragm valve
SMS 22,6/25	55	45	110	89	339	790	117	18	13	223	227	70	3,9	4
SMS 35,6/38	70	55	110	89	346	800	117	21	13	225	234	85	4,1	4,2
SMS 48,5/51	82	70	123	114	375	830	117	29	18	245	266	97	7	7,4
SMS 60,3/63,5	105	85	159	167	424	880	117	36	28	304	313	125	16,4	17,2
SMS 72,9/76,1	110	95	159	167	431	880	117	36	27	310	343	130	16,5	17,3
SMS 100/104	130	125	181	217	481	930	117	41	36	365	368	155	34,1	37,4
DIN 26/29	55	47	110	89	339	790	117	18	13	223	227	/	3,9	4
DIN 32/35	55	51	110	89	344	800	117	18	/	227	/	/	4	/
DIN 38/40	70	55	110	89	346	800	117	21	13	225	234	/	4,1	4,3
DIN 50/53	80	71	123	114	375	830	117	29	18	245	266	/	7	7,4
DIN 66/70	108	93	159	167	427	880	117	36	28	307	316	/	16,5	17,3
DIN 81/85	115	105	159	167	436	890	117	36	26	316	325	/	17	17,7
DIN 100/104	130	125	181	217	481	930	117	41	36	365	368	/	34,1	37,4
DIN 125/129	160	155	285	270	651	1100	117	73	52	517	538	/	70,1	77,8
DIN 150/154	180	180	285	270	664	1120	117	73	49	529	553	/	72	80,4
US 1" (22,1/25,4)	51	45	110	89	339	790	117	18	13	222	227	64	4	4,1
US 1"1/2 (34,8/38,1)	57,5	55	110	89	346	800	117	21	13	225	234	70	4,1	4,3
US 2" (47,5/50,8)	76	70	123	114	375	830	117	29	18	255	266	89	7,1	7,5
US 2"1/2 (60,2/63,5)	76	85	159	167	424	880	117	36	28	305	313	89	16,4	17,2
US 3" (72,9/76,1)	82	95	159	167	431	880	117	36	27	310	343	95	16,7	17,5
US 4" (97,4/101,6)	130	125	181	217	481	930	117	41	36	365	368	146	34,6	37,9

WEIGHT WITH SORIO CONTROL TOP		+ 0,9 kg
Diameter	125 DIN	+ 1,4 kg
	150 DIN	

*The dimensions are identical for the diaphragm version, except for the I and J dimensions and the weight.

TECHNICAL DATA

> Actuator air supply*

min 4.5 bar
max 7 bar

*Pressure with direct control top supply

> Pressure (bar)

	PFA	ELASTO	DIAPHRAGM
Maximum operating pressure	8	8	6

> Temperature (°C)*

	PFA /EPDM	PFA/FKM	ELASTO - EPDM	ELASTO - FKM	DIAPHRAGM/PFA
Min. static temperature	-5	5	-5	5	5
Max. static temperature	120	120	120	120	140
Min. dynamic temperature	-5	5	-5	5	5
Max. dynamic temperature	95	95	120	120	110
Flash steam temperature (20 minutes at maximum temperature)	140°C	140°C	140°C	140°C	140°C

* For pressure of 5 bar

DIAPHRAGM/PFA	STATIC	DYNAMIC
Steam flash (during 30 minutes)	150°C	110°C
Continuous steam	130°C	110°C

> Temperature differential between the upper channel and the lower channel: max. 120°C

> Temperature / Pressure ratio for the PFA seal

> Vacuum retention: 0.9 bar

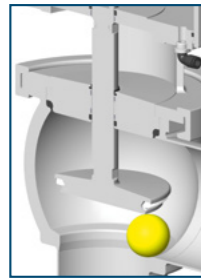

DCX3 particle passage standard stroke

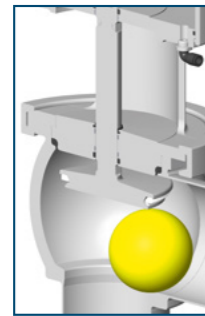

DCX3 PFA particle passage long stroke

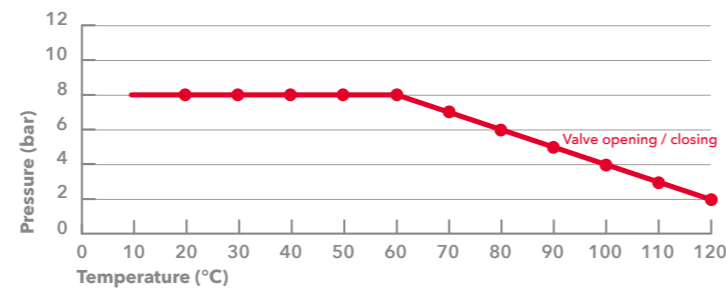

Specifications	SMS	UNIT	25		38		51		63		76		104		150						
	US		1"	1 1/2"	2"	2 1/2"	3"	4"	3"	4"	3"	4"									
	DIN 11850 REIHE 2	25	32	40	50	65	85	100	125	150											
Ø particle K standard DCX3	mm	12	12	12	16	16	16	24	24	24	29	29	29	30	34	34	34	66	67		
Ø particle K diaphragm DCX3	mm	6,5	6,5	6,5	6,5	6,5	6,5	11,5	11,5	11,5	20	20	20	20	30	30	30	40	40		
Ø particle K long stroke DCX3	mm	20	20	20	24	24	24	35	35	35	51	51	51	52	52	62	74	74	86	98	
Body wall thickness	mm	5	5	5	5	5	5	6	6	6	7	7	7	7	7	7	7	9	9		
Air consumption (volume at atmospheric pressure)	Standard DCX 3 shut-off valve	NI	0,25				0,5				1,25				2,25		4		4		
	Diaphragm DCX 3 shut-off valve	NI	0,125				0,25				0,875				2		2,5		2,5		
Operating time (with Sorio control top)	Valve opening	sec	0,5	0,5	0,5	0,5	0,5	0,5	1	1	1	1,5	1,5	1,5	1,5	1,5	2,6	2,6	2,6	11,4	11,4
	Valve closure	sec	0,7	0,7	0,7	0,7	0,7	0,7	1,5	1,5	1,5	3,3	3,3	3,3	3,3	3,3	6,5	6,5	6,5	15,5	15,5
	Quick drain	sec	<0,2	<0,2	<0,2	<0,2	<0,2	<0,2	<0,2	1	1	1	1,5	1,5	1,5	1,5	1,5	2,5	2,5	2,5	6

The operating conditions are given for information only. Combinations of extreme operating conditions may sometimes be inappropriate. In these cases, it is strongly advised to obtain advice from us.

LOSS OF PRESSURE DCX3 SHUT-OFF VALVES DN25 TO DN51

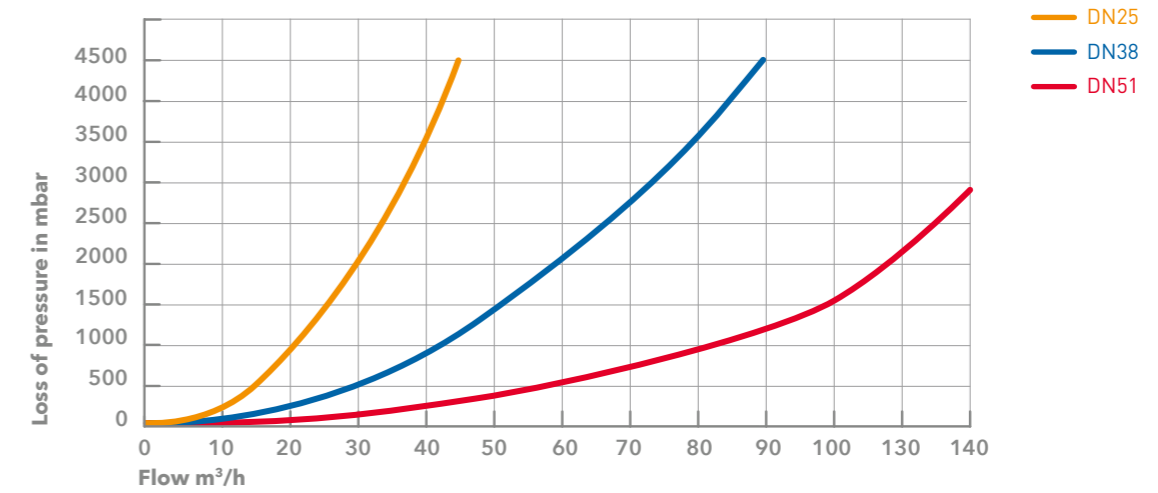

LOSS OF PRESSURE DCX3 SHUT-OFF VALVES DN63 TO DN150

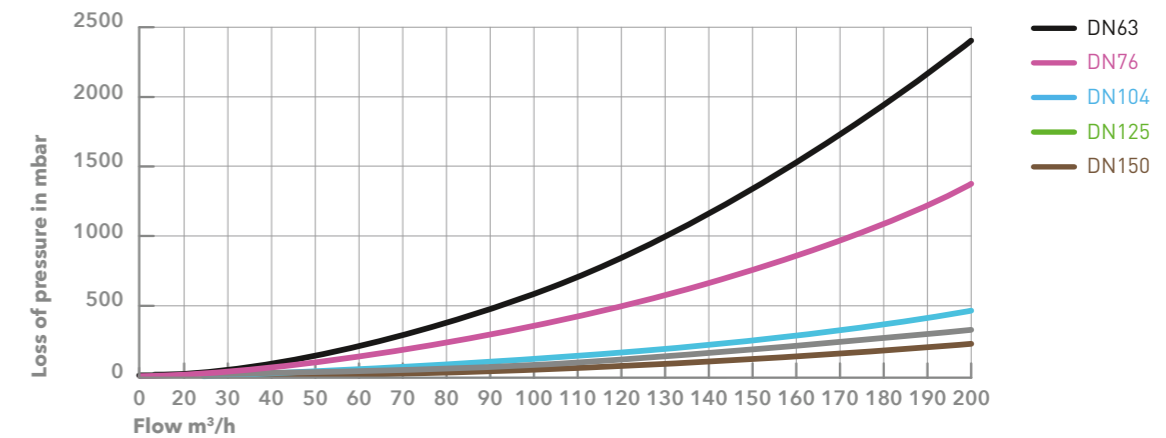

SMS	25	38	51	63	76	104	150							
US	1"	1 1/2"	2"	2 1/2"	3"	4"	3"							
DIN 11850 REIHE 2	25	32	40	50	65	80	100	125	150					
Loss of pressure Kv	21	24	36	42	44	82	85	128	142	170	190	290	348	418
Loss of pressure Cv	24,36	27,84	41,76	48,72	51,04	95,12	98,6	148,48	164,72	197,2	220,4	336,4	403,68	484,88

> Tribofinishing

Surface condition maximizing external and internal cleanability of the valves. For heavy-duty applications, erasure of external and internal welds upon request.

Surface condition	External	1.2 µm (150 grit)
	Internal	0.8 µm (180 grit)

FRACTIONAL SHUT-OFF VALVE DCX3 FRACT

These small, single-seated shut-off valves are characterised by high sealing pressures. They are used in the Starmotion pigging stations and Starwheel injection systems, among others.



AUTOMATIC FRACTIONAL SHUT-OFF VALVE

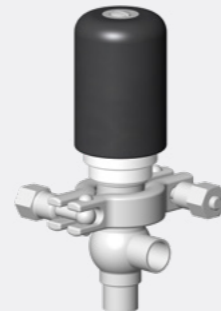

MANUAL FRACTIONAL SHUT-OFF VALVE

DCX3 AUTOMATIC FRACTIONAL

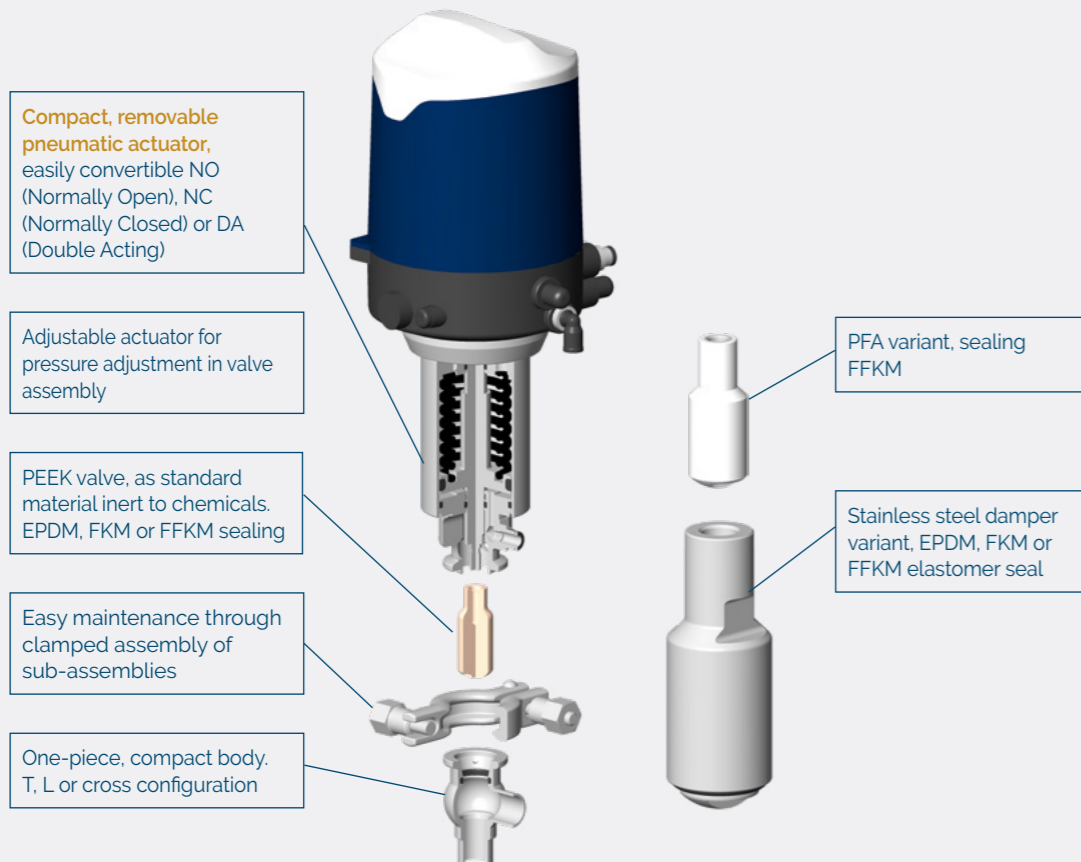

DIMENSIONS

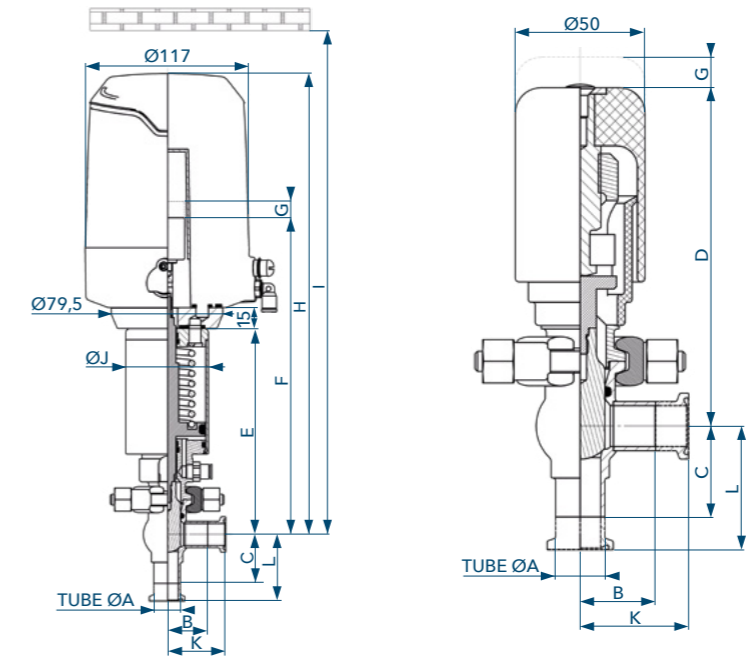

Automatic fractional DCX3 shut-off valve

Manual fractional DCX3 shut-off valve

TUBE Ø A	B	C	D	E	F	STROKE G	H	I	ØJ	K	L	Weight in kg DCX3 FRAC	
												Manual	Automatic
US 1/2" (12,7 x 1,65)	27,5	30	128	145	225	12	328	600	59	40	42,5	0,8	1,6
US 3/4" (19,05 x 1,65)	29	35	131	148	227	12	331	600	59	41,5	47,5	0,8	1,7
US 1" (25,4 x 1,65)	33,5	40	131	163	243	15	346	650	71	46	52,5	1,2	2,5

WEIGHT WITH SORIO CONTROL TOP + 1,3 kg

OPERATING CONDITIONS

MANUAL AND AUTOMATIC FRACTIONAL DCX3 SHUT-OFF VALVE

DN	Maximum sealing pressure	Maximum operating pressure	Resistance to vacuum	Passage of particle	Temperature		
					Maxi	Mini	Delta
1/2"	18 bar (1800 kPa)	16 bar (1600 kPa)	-0,9 bar	8 mm	140°C	-5°C	120°C
3/4"	18 bar (1800 kPa)	16 bar (1600 kPa)	-0,9 bar	9 mm	140°C	-5°C	120°C
1"	18 bar (1800 kPa)	16 bar (1600 kPa)	-0,9 bar	12 mm	140°C	-5°C	120°C

AUTOMATIC FRACTIONAL DCX3 SHUT-OFF VALVE

DN	Operating time	Air consumption	Actuator supply pressure		Loss of pressure (Kv)	Loss of pressure (Cv)
			Maxi	Mini		
1/2"	0,5 s	0,3 NI	8 bar (800 kPa)	4,5 bar (450 kPa)	3,2	3,71
3/4"	0,5 s	0,3 NI	8 bar (800 kPa)	4,5 bar (450 kPa)	10,7	12,4
1"	0,75 s	0,5 NI	8 bar (800 kPa)	4,5 bar (450 kPa)	21	24,36

LOSS OF PRESSURE DCX3 SHUT-OFF VALVES

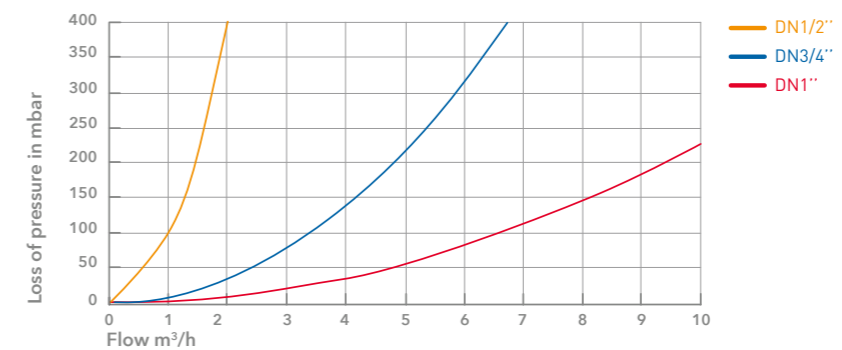

REVERSE DCX3 SHUT-OFF VALVE

To complete the range of isolation valves and offer a greater combination of body configurations, the DCX3 shut-off valve is available in a REVERSE version. This valve manages any direction of flow, ensuring optimal sealing performance.

It can be easily integrated into your existing lines.

Its configuration makes it easy to install on parallel pipelines.

This valve is optimised for pressures arriving below the plug.

The solid bodies are assembled by Tri-clamp, to meet all orientation constraints.

The operating conditions are identical to the standard DCX3 version.



REVERSE DCX3 SHUT-OFF VALVE
L/L CONFIGURATION



ONLY AVAILABLE IN ELASTOMER
VERSION (EPDM OR FKM)

OPERATING PRINCIPLE REVERSE DCX3

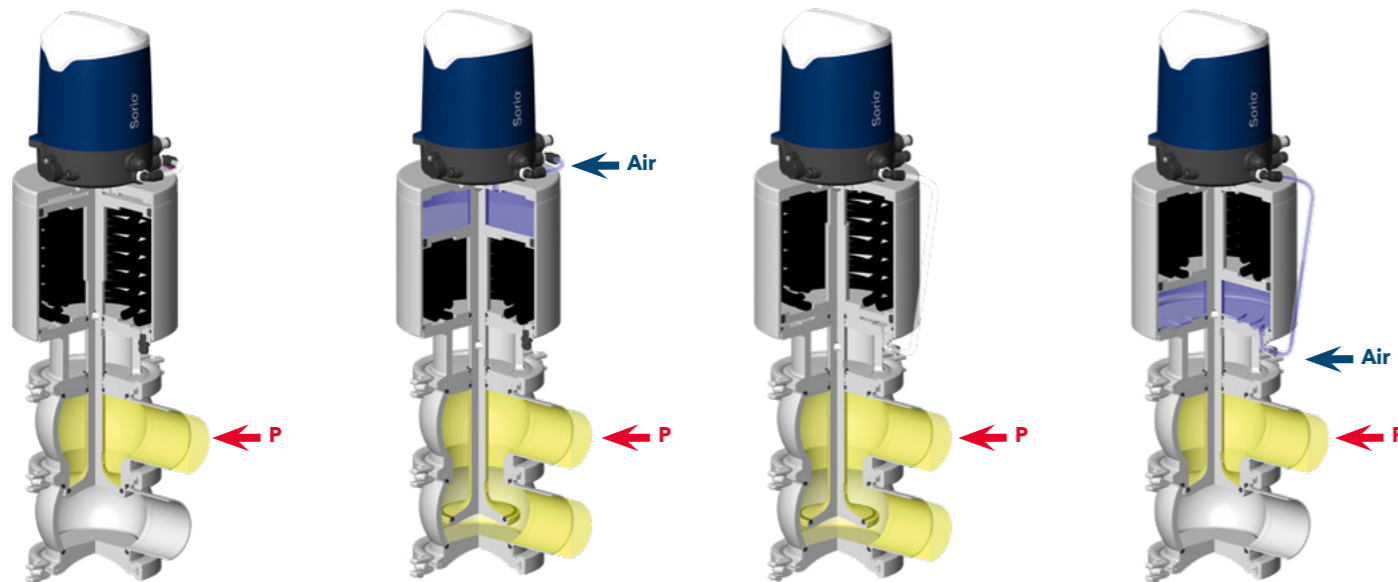

CLOSED POSITION

OPEN POSITION

OPEN POSITION

CLOSED POSITION

NF - NORMALLY CLOSED

NO - NORMALLY OPEN

DIMENSIONS

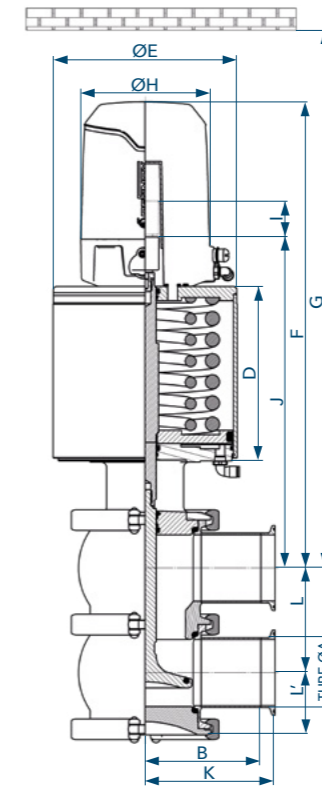

TUBE Ø A	B	D	Ø E	F	G	Ø H	Stroke I	J	K	L	L'	Weight in kg without control top
SMS 22,6/25	55	110	89	339	790	117	15	216	70	55	36,5	5,9
SMS 35,6/38	70	110	89	346	800	117	22	222	85	70	45,15	6,3
SMS 48,5/51	82	123	114	375	830	117	29	252	97	80	47,65	9,8
SMS 60,3/63,5	105	159	167	424	880	117	36	301	125	95	56,5	21,5
SMS 72,9/76,1	110	159	167	431	880	117	36	307	130	105	60,15	21,8
SMS 100/104	130	181	217	481	930	117	43	359	155	150	91,15	50,6
DIN 26/29	55	110	89	339	790	117	11	220	/	55	36,5	5,9
DIN 32/35	55	110	89	344	800	117	22	221	/	65	41,95	6,2
DIN 38/40	70	110	89	346	800	117	22	222	/	70	45,15	6,3
DIN 50/53	80	123	114	375	830	117	29	252	/	80	47,65	9,9
DIN 66/70	108	159	167	427	880	117	36	304	/	100	58,5	21,9
DIN 81/85	115	159	167	436	890	117	36	313	/	130	79,65	23,8
DIN 100/104	130	181	217	481	930	117	43	359	/	150	91,15	50,6
DIN 125/129	160	285	270	651	1100	117	77	508	/	165	92,65	92,6
DIN 150/154	180	285	270	664	1120	117	76	520	/	195	110,15	96,8
US 1" (22,1/25,4)	51	110	89	339	790	117	22	216	64	82,5	36,5	6,2
US 1"1/2 (34,8/38,1)	57	110	89	346	800	117	22	222	70	82,5	45,15	6,4
US 2" (47,5/50,8)	76	123	114	375	830	117	29	252	89	95	47,65	10,1
US 2"1/2 (60,2/63,5)	76	159	167	424	880	117	36	301	89	108	56,5	21,8
US 3" (72,9/76,1)	82	159	167	431	880	117	36	307	95	120	60,15	22,2
US 4" (97,4/101,6)	130	181	217	481	930	117	43	359	146	165	91,15	51,6

WEIGHT WITH SORIO CONTROL TOP		+ 0,9 kg
Diameter	125 DIN	+ 1,4 kg
	150 DIN	

CUSTOMER SERVICE

PERSONALIZED SUPPORT

Our customer services offer training and maintenance services and assist you with the management of your spare parts.



AUTONOMY OF INTERVENTION ON YOUR INSTALLED VALVES FLEET

With theoretical and practical training adapted to your needs, on site or at Definox*.

*Definox is Qualiopi certified

SAFE OPERATIONS

Maintenance can be carried out with standard tools.

For greater efficiency and safety during maintenance, we offer a dismantling press and a tool case.

MAINTENANCE ADVICE

You can find all our tips for working on DCX3 valves in the maintenance and installation manuals. Before working on our valves, it is recommended to use the appropriate tooling kits.



Follow the step-by-step disassembly and reassembly of DCX3 valves on the maintenance video, available on YouTube and [definox.com](https://www.definox.com)

PERSONALISED MONITORING PROGRAMME FOR THE VALVES FLEET

Our teams of specialised technicians operate in France and abroad for the maintenance of valves.

Our actuators are guaranteed for 5 years from delivery under normal operating conditions with a dry filtered air supply according to DIN/ISO 8573-1.

We recommend replacing the wearing parts of the actuator at the end of the warranty period and every 5 years thereafter.

WARRANTY ON ORIGINAL SPARE PARTS

- Designed and selected specifically for DEFINOX products.
- Interchangeable parts for optimised spare parts stock management.
- The valve design reduces the number of seals.



DOWNLOAD, SCAN, BROWSE...

The augmented reality developed by DEFINOX for more services.

- Immediate identification of the valve and spare parts
- Saves time on valve fleet management
- Reduced risk of errors
- Immediate access to documentation
- Individualized monitoring of the valve with the service book function 

THE SERVICE BOOK

Saves you time in managing your valve fleet and allows you to monitor each valve individually.

- > Monitoring of preventive and corrective maintenance.
- > Reminder of the next maintenance dates.
- > Adding intervention reports, notes, photos and equipment identification tags



MOBILE APPLICATION,
FREE TO DOWNLOAD AND
ACCESSIBLE FROM YOUR SMARTPHONE



SPECIALIST FOR OVER 50 YEARS

Specialist in the transfer of liquids for more than 50 years, DEFINOX designs and manufactures process valves and customized equipment in stainless-steel for the food, cosmetic and fine chemicals industries.



70 
COUNTRIES

60,000 
EQUIPMENT AND VALVES
SOLD PER YEAR

150 
EMPLOYEES



MACHINING IN THE BODIES



WELDING OPERATION



HEAT TREATMENT



ASSEMBLY OF PROCESS VALVES

FIELDS OF APPLICATION

DEFINOX valves can be used on liquids or semi-liquids, more or less viscous, without risk of denaturing the manufactured product.

- Food: dairy products, jam, chocolate...
- Cosmetics / Perfume
- Hygiene products: toothpaste, shampoo, shower gel...
- Household products: laundry, detergent...
- Animal food
- Paint
- Lithium battery



DEFINOX, FLEXIBILITY AND PERFORMANCE

The machining, turning and welding techniques selected by DEFINOX for the production of valves, pigging solutions and personalized equipment give strategic components in contact with the fluid a high level of finish and quality and in accordance with process requirements.

Mass-machines of the bodies is the guarantee of manufacturing parts without retention zones. This process provides great resistance to mechanical and thermal deformation. The spherical shape of the bodies promotes optimum fluid flow and a reduction in pressure losses.

Milling and turning operations offer great flexibility to adapt the outlet pipes. Many configurations are thus made possible.

The internal polishing (Ra = 0.8 µm or 180 grit) contributes to a good in-line cleanability. This is the assurance of a finish that complies with health requirements. A passivation operation reinforces the corrosion resistance.

The quality of the welds (made by TIG certified welders) meets health standards and requirements. The welds guarantee good geometry and resistance of the mechanically welded assemblies.

DEFINOX is committed to a Lean Manufacturing approach and continuous improvement. Our industrial and organizational choices optimize our production flows and provide the flexibility necessary to produce specific valves or specific equipment according to customer needs.





ENGINEERING DEPARTMENT

Our engineering department provides knowledge in IO-Link technology associated with process valves and liquid transfer.

It advises and supports your approach to implement predictive valve maintenance.

A renowned French brand, DEFINOX specializes in the design and production of units that meet specific customer specifications.

(valve manifolds, pigging solutions, injection systems ...).

The valves and equipment meet the standards of the regulations in force applicable to hygienic processes and the most severe constraints in terms of cleanability.

[definox.com](https://www.definox.com)

AND FOLLOW US ON:



DEFINOX SAS

3 rue des Papetiers - ZAC Tabari Sud
44190 CLISSON - FRANCE

Tél. +33 (0)2 28 03 98 50 - info@definox.com

DEFINOX Beijing

Stainless Steel Equipment Ltd - No 18 East Road
An Ning Zhuang Quinghe - Beijing Haidian District
BEIJING 100085 - CHINA

Tél. +86 10-6293-4909 - msn@definox.com.cn

DEFINOX Inc

16720 W. Victor Road - New Berlin
53151 WISCONSIN - USA

Tél. +1 262-797-5730 - sales@definox-usa.com