

VENAIR
FOOD-
PHARMA

**FLEXIBLE SILICONE HOSES FOR
THE FOOD AND PHARMACEUTICAL INDUSTRIES**



venair



Sistema de
Gestión
ISO 9001:2015
ISO 14001:2015



www.tuv.com
ID 0910078058

VENAIR

VENAIR IS AN INTERNATIONAL GROUP LEADER IN ENGINEERING AND MANUFACTURING SILICONE HOSES FOR THE MOST DEMANDING INDUSTRIES SUCH AS PHARMACEUTICAL, BIOTECHNOLOGICAL, FOOD, CHEMICAL AND COSMETIC.

More than 30 years of history, Venair has created an extensive international network that has led to three manufacturing centers in Spain, Vietnam and Romania and 30 delegations distributed in Europe, America and Asia. Thanks to Venair's internationalization strategy, accompanied by a commitment to deliver high-quality products and a constant focus on the customer's needs, today we market our wide range of products worldwide.

Whatever the nature of the fluid you convey, its temperature, concentration, working pressure or even the type of cleaning cycles used in your process, Venair emerges as the specialist in the transfer of liquid, pasty products or even solids offering a wide range of flexible solutions and customized pieces in silicone and other materials.

We hold the management certificates ISO 9001, ISO 14001, EMAS and also the product 3A 62-02 & 18-03 standards, apart from the full product validations required by the top pharmaceutical and biotech industries.

INNOVATION AS A HALLMARK

Innovation is part of Venair Group's DNA, whose leading position is a direct result of great efforts in R&D projects. Over the past years, the company has implemented a new strategic innovation policy aimed at boosting its line of value-added products for the most demanding industries and improving the company's competitiveness.

Venair TechLab, which integrates all R&D projects in the Venair Group, is the face of the commitment to innovation and development.

The main customers in the Food&Pharm industry include multinationals such as Johnson&Johnson, Pfizer, Sanofi, Colgate, Novartis, Bayer, GlaxoSmithKline, Müller, Eli Lilly, Merck, Premier Foods, Guinness, Danone, Nestlé, L'Oreal, Henkel and Coca-Cola.



Watch our
corporate video.

ALL VENAIR'S FOOD&PHARMA RANGE OF PRODUCTS IS MADE WITH A FULLY VALIDATED SILICONE

> FROM THE SIMPLEST FOOD APPLICATION TO THE MOST TECHNICAL BIOPROCESS, VENAIR PROVIDES ITS PRODUCTS WITH THE SAME AND COMPLETELY VALIDATED SILICONE, AVOIDING ANY CROSS CONTAMINATION.

> VENAIR DOES NOT USE PEROXIDE CURED SILICONE IN THE SAME PLANTS WHERE FOOD&PHARMA PRODUCTS ARE MANUFACTURED.

> UNDER REQUEST, WE CAN DELIVER AN EXTENSIVE LEACHABLES AND EXTRACTABLES STUDY.

> ADVANTAGES:

- Animal derived component free (ADCF).
- Platinum cured and post cured to reduce extractables levels.
- Gamma stable and autoclavable.
- Low water absorption and low gas permeability rating.
- Minimal extractables help maintain fluid integrity
- Documented biocompatibility for sensitive applications.

THEREFORE, ALL OUR SILICONE PRODUCTS COMPLY WITH THE FOLLOWING REGULATIONS:

VALIDATION PACKAGE

REFERENCE	TITLE
(EU) No 10/2011	Plastic materials and articles intended to come into contact with food
(EU) No 1935/2004	Simulant B (3% Acetic acid aqueous solution) and Simulant D1 (50% ethanol)
FDA 21 CFR 177.2600	Rubber articles intended for repeated use, FDA ITEM 177.2600 (e)
BfR recommendation XV	Recommendations on the health assessment of plastics and other high polymers
United States Pharmacopoeia <88>	Biological reactivity tests, IN VIVO Class VI - 121°C
ISO 10993-4	Biological evaluation of medical devices—Part 4: Selection of tests for interactions with blood
ISO 10993-5 & USP <87>	Biological evaluation of medical devices – Part 5: Tests for in vitro cytotoxicity
ISO 10993-6	Biological Evaluation of medical Devices – Part 6: Tests for Local Effects After Implantation
ISO 10993-10	Biological Evaluation of medical Devices – Part 10: Tests for Irritation and Skin Sensitization
3A 18-03	Sanitary Standard Procedure N° 18-03 Class I
European Pharmacopoeia 3.1.9.	Silicone elastomer for closures and tubing
Extractables and Leachables study available for 70ShA silicone	Extraction experiment in organic solvent
	Extraction experiment in polar organic-aqueous solvent system
	Extraction experiment in aqueous solvent, alkaline conditions
	Extraction experiment in aqueous solvent, acidic conditions

VENA[®] SIL 630

Transparent wire-reinforced silicone hose



> MATERIAL:

Platinum cured silicone in accordance with the main food and pharm certifications.

> CERTIFICATIONS:

- Complete Validation Package. Check page 4.
- 3A Sanitary Standard 62-02 (fitted hoses).
- Material used is in accordance with EU Directive 2015/863 for Restriction of the use hazardous substances (RoHS 3)

> FABRIC REINFORCEMENT: No

> STAINLESS STEEL INSIDE:

Stainless steel wire spring encased inside the hose wall.

> INNER APPEARANCE:

Transparent and completely smooth.

> MAXIMUM LENGTH OF MANUFACTURE:

The standard length of manufacture is 4m (13'). Upon request, 6m length hoses (19' 8") can be manufactured for some diameters.



TEMPERATURE SCALE:

-55°C / +200°C
(-67°F / +392°F)



VACUUM PRESSURE:

0,80 bar (11,6 psi)



TECHNICAL TABLE ON PAGE: 36

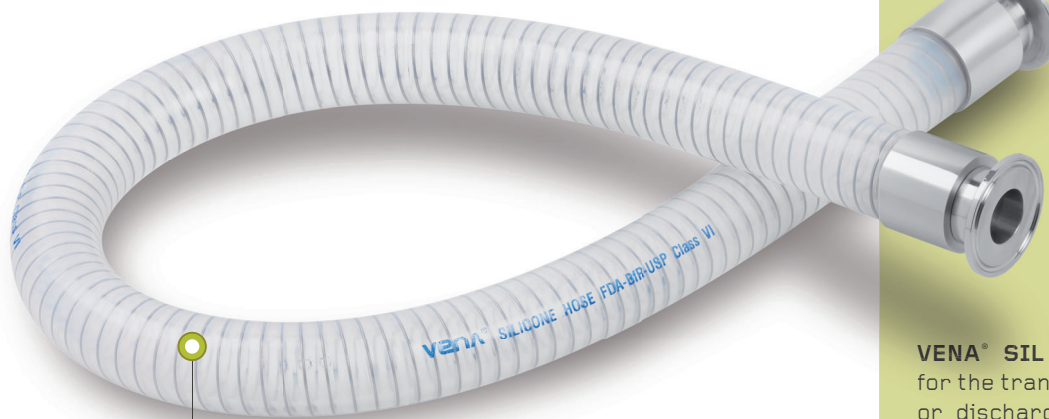

OUTER APPEARANCE:

Transparent and smooth.

APPLICATIONS:

VENA[®] SIL 630 is suitable for the transport by suction or discharge of liquid, semi-liquid or solid products in the food, cosmetic, pharm and biotech industries. Its high flexibility and tight bending radius make it suitable for repetitive movements in dosing and filling machines. It is specifically designed to absorb vibrations and to compensate level differences. Its high translucence allows a perfect view of the conveyed product.

VENA[®] SIL 640

Polyester fabric reinforced silicone hose



> MATERIAL:

Platinum cured silicone produced in accordance with the main food and pharm certifications.



OUTER APPEARANCE:

Translucent, white or colored, and smooth.



APPLICATIONS:

VENA[®] SIL 640 is suitable for the transport by impulsion of liquid, semi-liquid or solid products in the food, cosmetic, pharm and biotech industries. It is recommended for dosing and filling machines in straight sections. This model is often used in straight sections equipped with metal fittings terminals, where flexibility is not

required and to detect metal particles which may occur during filling of food products such as cream or baby food. This model is not recommended for vacuum.

> CERTIFICATIONS:

- Complete Validation Package. Check page 4.
- 3A Sanitary Standard 62-02 (fitted hoses).
- Material used is in accordance with EU Directive 2015/863 for Restriction of the use hazardous substances (RoHS3)

> FABRIC REINFORCEMENT:

Polyester fabric reinforcement.

> STAINLESS STEEL INSIDE: No

> INNER APPEARANCE:

Translucent and smooth.

> MAXIMUM LENGTH OF MANUFACTURE:

The standard length of manufacture is 4m (13'). Upon request, 6m length hoses (19' 8") can be manufactured for some diameters.



TEMPERATURE SCALE:

-55°C / +180°C
(-67°F / +356°F)



TECHNICAL TABLE
ON PAGE: 36

VENA® SIL 650V

Fabric and wire reinforced silicone hose



> MATERIAL:

Platinum cured silicone produced in accordance with the main food and pharm certifications.

> CERTIFICATIONS:

- Complete Validation Package. Check page 4.
- 3A Sanitary Standard 62-02 (fitted hoses).
- Material used is in accordance with EU Directive 2015/863 for Restriction of the use hazardous substances (RoHS 3)

> FABRIC REINFORCEMENT:

Polyester fabric reinforcements.

> STAINLESS STEEL INSIDE:

Stainless steel wire spring encased inside the hose wall.

> INNER APPEARANCE:

Translucent and smooth.

> MAXIMUM LENGTH OF MANUFACTURE:

The standard length of manufacture is 4m (13'). Upon request, 6m length hoses (19' 8") can be manufactured for some diameters.



TEMPERATURE SCALE:

-55°C / +180°C
(-67°F / +356°F)



VACUUM PRESSURE:

0,91 bar (13,23 psi)



TECHNICAL TABLE ON PAGE: 37



OUTER APPEARANCE:

Translucent, white or colored, and smooth.

APPLICATIONS:

VENA® SIL 650V is the most popular hose of this range since it offers a perfect balance between its construction and flexibility and its pressure resistance. It is suitable for the transport by suction or impulsion of liquid, semi-liquid or solid products in the food, cosmetic, pharm and biotech industries.

Its high flexibility and tight bending radius make it suitable for repetitive movements in dosing and filling machines. It is specifically designed to absorb vibrations and to compensate level differences.

VENA® SIL 650V LASTIC

Fabric and wire reinforced silicone hose



> MATERIAL:

Special silicone, formulated by Venair®, with excellent elastic properties manufactured with three polyester fabric reinforcements and a stainless steel wire spring.

> CERTIFICATIONS OF THE INNER LAYER:

- US FDA Standard 21 CFR 177.2600
- USP Class VI <88> in vivo tests
- ResAp 2004 (5), according to Reg 1935/2004/EEC, and Reg 10/2011/EEC
- Material used is in accordance with EU Directive 2015/863 for Restriction of the use hazardous substances (RoHS 3)

> FABRIC REINFORCEMENT: Yes

> STEEL INSIDE:

Steel wire spring encased inside the hose wall.

> OUTER APPEARANCE:

Translucent and smooth.

> INNER APPEARANCE:

Translucent and smooth.

> MAXIMUM LENGTH OF MANUFACTURE:

6 meters (19.69ft).



TEMPERATURE SCALE:

-55°C / +180°C
(-67°F / +356°F)
Peaks up to 200°C (392°F)



TECHNICAL TABLE
ON PAGE: 38



APPLICATIONS:

VENA® SIL 650/V LASTIC is recommended especially when a smaller bending radius is required; even smaller bending radius can be achieved compared with the standard 650/V. These hoses are able to transport liquid or semi-liquid foodstuffs at high temperatures by impulsion or suction, since their design can resist pressure or vacuum.

VENA® SIL 650V PLASTIC

Fabric and wire reinforced silicone hose



> MATERIAL:

Platinum cured silicone produced in accordance with the main food and pharm certifications and manufactured with plastic wired, everything encased inside the hose.

> CERTIFICATIONS:

- Complete Validation Package. Check page 4.
- Material used is in accordance with EU Directive 2015/863 for Restriction of the use hazardous substances (RoHS 3).

> STAINLESS STEEL INSIDE:

Plastic wire.

> FABRIC REINFORCEMENT: Yes

> OUTER APPEARANCE:

White and smooth.

> INNER APPEARANCE:

Translucent and smooth.

> MAXIMUM LENGTH OF MANUFACTURE:

6 meters (19.69ft).



TEMPERATURE SCALE:

-55°C / +180°C
(-67°F / +356°F)
Peaks up to 200°C (392°F)



TECHNICAL TABLE
ON PAGE: 38



APPLICATIONS:

Specifically designed when a smaller bending radius is required. These hoses are able to transport liquid or semi-liquid foodstuffs at high temperatures by impulsion or suction, since their design can resist pressure or vacuum. It is especially recommended for applications where metal detection is required. It also avoids oxidation.

VENA[®]SIL 655

Fabric and double wire spring reinforced silicone hose



> MATERIAL:

Platinum cured silicone produced in accordance with the main food and pharm certifications.

> CERTIFICATIONS:

- Complete Validation Package. Check page 4.
- 3A Sanitary Standard 62-02 (fitted hoses).
- Material used is in accordance with EU Directive 2015/863 for Restriction of the use hazardous substances (RoHS 3).

> FABRIC REINFORCEMENT:

Polyester fabric reinforcement.

> STAINLESS STEEL INSIDE:

Double stainless steel wire spring encased inside the hose wall at different levels.

> INNER APPEARANCE:

Translucent and smooth.



VACUUM PRESSURE:
0,91 bar (13,23 psi)



> MAXIMUM LENGTH OF MANUFACTURE:

The standard length of manufacture is 4m (13'). Upon request, 6m length hoses (19' 8") can be manufactured for some diameters.

OUTER APPEARANCE:

Translucent, white or colored, and smooth.

APPLICATIONS:

It is the most pressure resistant hose of the VENA[®]SIL range since it has a double wire reinforcement. Designed for use at specific situations where there may be sudden high pressure surges (hammering).



TECHNICAL TABLE ON PAGE: 37



TEMPERATURE SCALE:
-55°C / +180°C
(-67°F / +356°F)

VENA[®]SIL FDA-X

Conductive silicone hose

All our standard hoses from the Vena Sil range can be modified in order to reduce the Electrical Resistivity.

- Electrical Surface Resistance is 10^3 Ohm according to the specification indicated in part 26.13 of EN 60079-0:2006.
- The hose must be properly grounded, to permit the correct dissipation of the static charge (grounding the hose metal fittings or directly the copper wire of both ends of the hose). Will be customer's responsibility to properly ground the hose.
- Vena Sil FDA-X is suitable for its use in ATEX certified zones*.

> MAXIMUM LENGTH OF MANUFACTURE:

The standard length of manufacture is 4m (13'). Upon request, 6m length hoses (19' 8") can be manufactured for some diameters.

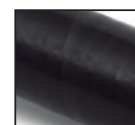

OUTER APPEARANCE:
Black and smooth.



*This product can be mounted in ATEX installations (Explosive Atmospheres) which must, in any case, be certified retrospectively by the relevant competent authority.

VENA® BIO PURE

Translucent silicone tubing



> MATERIAL:

Platinum cured silicone produced in accordance with the main food and pharm certifications.

> CERTIFICATIONS:

- Complete Validation Package. Check page 4.
- Material used is in accordance with EU Directive 2015/863 for Restriction of the use hazardous substances (RoHS3).

> FABRIC REINFORCEMENT: No

> **HARDNESS:** Available in 60 ShA, 70 ShA and 80 ShA.

> STAINLESS STEEL INSIDE: No

> INNER APPEARANCE:

Translucent and smooth.

> STANDARD LENGTH OF MANUFACTURE:

50ft (15,24m) and 100ft (30,48m). Other lengths on demand.

> FEATURES:

Manufactured and double bagged in clean room ISO 7 according ISO 14644-1.

> **ALTERNATIVE:** **Bio Pure HP** for pressure resistance



TEMPERATURE SCALE:

-55°C / +200°C
(-67°F / +392°F)



TECHNICAL TABLE ON PAGE: 40

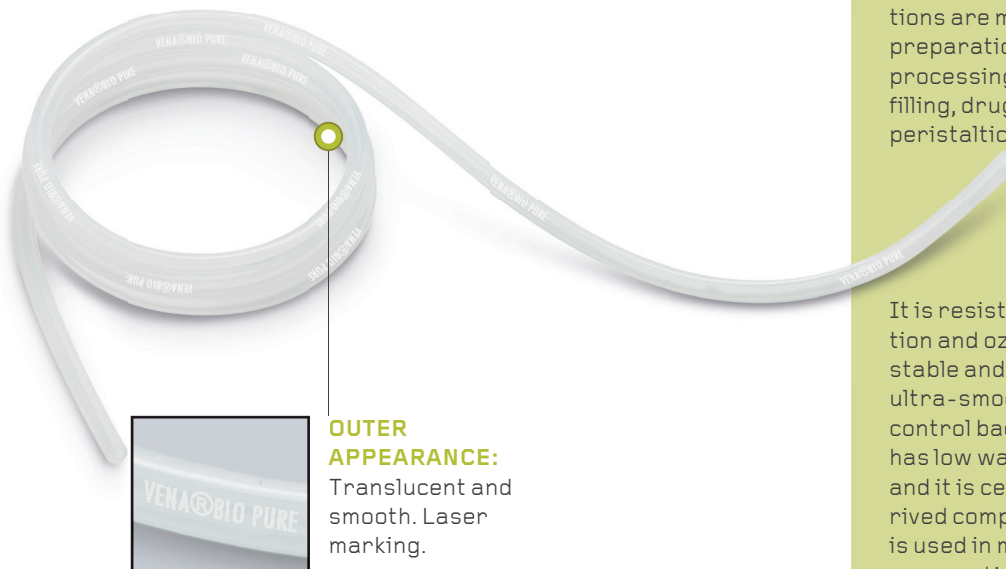

OUTER APPEARANCE:

Translucent and smooth. Laser marking.

APPLICATIONS:

It is recommended for the transfer of fluids at very low pressure in filling processes of liquids and semi-liquids. It compensates vibration and level differences. Typical applications are media and buffer preparation, downstream processing, formulation, filling, drug delivery and peristaltic pumps.

It is resistant to UV, radiation and ozone. It is gamma stable and autoclavable. Its ultra-smooth bore helps to control bacterial growth. It has low water absorption and it is certified Animal derived component free. Also, is used in media and buffer preparation and distribution in biopharmaceuticals manufacturing processes. Not recommended for vacuum pressures. Its Platinum curation and post curation reduces extractable levels.

VENA® TECHNOSIL

**Polyester braided
silicone tubing**



> MATERIAL:

Platinum cured silicone produced in accordance with the main food and pharm certifications.

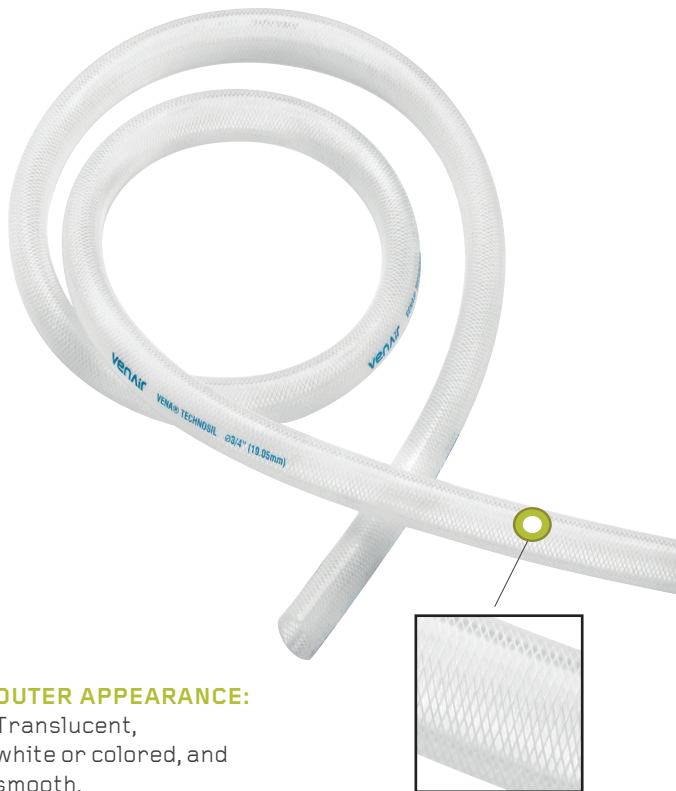

OUTER APPEARANCE:

Translucent, white or colored, and smooth.

CERTIFICATIONS:

- Complete Validation Package. Check page 4.
- 3A Sanitary Standard 62-02 (fitted hoses).
- Material used is in accordance with EU Directive 2015/863 for Restriction of the use hazardous substances (RoHS 3).

> FABRIC REINFORCEMENT:

Polyester braiding.

> STAINLESS STEEL INSIDE: No

> INNER APPEARANCE:

Translucent and smooth.

> STANDARD LENGTH OF MANUFACTURE:

10m and 20m (33ft and 66ft)

> **ALTERNATIVE:** VENA BIO BRAIDED. Manufactured and double bagged in clean room ISO 7 according ISO 14644-1.

APPLICATIONS:

Vena® Technosil is suitable for the transport by impulsion of liquid, semi-liquid or solid products in the food, cosmetic, pharm and biotech industries. It is recommended for repetitive movements in dosing and filling machines where no tight bending radius is needed. It is used in applications which require long lengths. It is recommended for downstream processes in the pharma and biopharma industries. It is resistant to UV, radiation and ozone. It is gamma stable and autoclavable. Its ultra-smooth bore helps to control bacterial growth. Its Platinum curation and post-curation reduces extractable levels. It has low water absorption and it is certified Animal derived component free.



**TECHNICAL TABLE
ON PAGE: 39**



TEMPERATURE SCALE:

-55°C/+180°C
(-67°F/+356°F)

VENA® TECHNOSIL DB

Double polyester braided
silicone tubing



> MATERIAL:

Platinum cured silicone produced in accordance with the main food and pharm certifications.



TEMPERATURE SCALE:

-55°C/+180°C
(-67°F/+356°F)

CERTIFICATIONS:

- Complete Validation Package. Check page 4.
- 3A Sanitary Standard 62-02 (fitted hoses).
- Material used is in accordance with EU Directive 2015/863 for Restriction of the use hazardous substances (RoHS 3).

> **STAINLESS STEEL INSIDE:** No

> INNER APPEARANCE:

Translucent and smooth.

> STANDARD LENGTH OF MANUFACTURE:

10m (33ft) and 20m (66ft).



TECHNICAL TABLE

ON PAGE: 39

> FABRIC REINFORCEMENT:

Double polyester braiding.



OUTER APPEARANCE:

White
and smooth.

APPLICATIONS:

Due to its special construction, this product is specially recommended for applications where a high pressure resistance and a small bending radius are required. It is not recommended for vacuum.

It is resistant to UV, radiation and ozone. It is gamma stable and autoclavable. Its ultra-smooth bore helps to control bacterial growth. It has low water absorption and it is certified Animal derived component free. Its Platinum curation and post-curation reduces extractable levels.

VENAFLO[®] HF

PFA silicone hose

VENAFLO: THE BEST SOLUTIONS TO CONVEY AGGRESSIVE PRODUCTS



> MATERIAL:

Platinum cured silicone hose with an inner liner of PFA fluoropolymer which is in accordance with the main food and pharm certifications.

APPLICATIONS:

The inner layer of PFA makes the hose very resistant to liquids and semi liquids and aggressive chemical products. The construction of this hose allows the conveying of products at high temperatures by suction or discharge, as the new design makes it resistant to pressure and vacuum.



> CERTIFICATIONS OF THE INNER LAYER:

- US FDA Standard 21 CFR 177.1550
- USP Class VI <88> in vivo tests
- USP Class VI <87> in vitro tests
- ISO 10993-5, 10 y 11
- Reg 1935/2004/EEC, and Reg 10/2011/EEC
- Material used is in accordance with EU Directive 2015/863 for Restriction of the use hazardous substances (RoHS 3.)

> FABRIC REINFORCEMENT:

Yes

> STAINLESS STEEL INSIDE:

Stainless steel wire spring encased inside the hose wall.

> INNER APPEARANCE:

White and smooth.

> MAXIMUM LENGTH OF MANUFACTURE:

20m (65,62ft) with INOX 316L connections (and others under demand).

> **ALTERNATIVE:** VENAFLO with inner liner of PTFE material.



OUTER APPEARANCE:

Translucent and smooth.



VACUUM RESISTANCE:
0,9 bar (13,05 psi)



TEMPERATURE SCALE:
-30°C/+150°C
(-22°F/+302°F)



TECHNICAL TABLE ON PAGE: 47

VENAFLO[®] HF-X

Conductive PFA silicone hose

VENAFLO[®]: THE BEST SOLUTIONS TO CONVEY AGGRESSIVE PRODUCTS



> MATERIAL:

Platinum cured silicone hose with inner liner of conductive black-colored layer of PFA fluoropolymer in accordance with the main food and pharm certifications.

> CERTIFICATIONS OF THE INNER LAYER:

- US FDA Standard 21 CFR 177.1550
- USP Class VI <88> in vivo tests
- USP Class VI <87> in vitro tests
- ISO 10993-5, 10 y 11
- Material used is in accordance with EU Directive 2015/863 for Restriction of the use hazardous substances (RoHS 3).

> ELECTRICAL PROPERTIES:

- Venaflon[®] HF-X is suitable for its use in ATEX certified zones*.

> FABRIC REINFORCEMENT: Yes

> STAINLESS STEEL INSIDE:

Stainless steel wire spring encased inside the hose wall.

> INNER APPEARANCE:

Black and smooth.

> MAXIMUM LENGTH OF MANUFACTURE:

20m (65,62ft) with INOX 316L connections (and others under demand).

> RESISTIVITY:

The inner PFA layer of this hose presents a low resistivity ($R < 10^6 \Omega$).



TEMPERATURE SCALE:

-30°C/+150°C
(-22°F/+302°F)



VACUUM RESISTANCE:

0,9 bar (13,05 psi)



TECHNICAL TABLE
ON PAGE: 47

APPLICATIONS:

This hose present a wide field of application due to its construction which gives it a balance between strength and lightness. The inner layer for this hose is made of antistatic PFA (Perfluoroalkoxy) which has a high compatibility with highly aggressive chemicals. This hose is able to transport liquid or semi-liquid food-stuffs by impulsion or suction, since its design can resist either pressure or vacuum. This product is specifically recommended to food and pharma applications where it is required a high conductivity to avoid electrostatic charge of the hose.

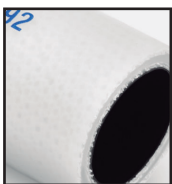

OUTER APPEARANCE:

Translucent and smooth.

*This product can be mounted in ATEX installations (Explosive Atmospheres) which must, in any case, be certified retrospectively by the relevant competent authority.

VENAFLO[®] HR

Highly resistant PFA hose

VENAFLO[®]: THE BEST SOLUTIONS TO CONVEY AGGRESSIVE PRODUCTS



> MATERIAL:

EPDM blue color rubber with inner liner of PFA fluoropolymer in accordance with the main food and pharm certifications.

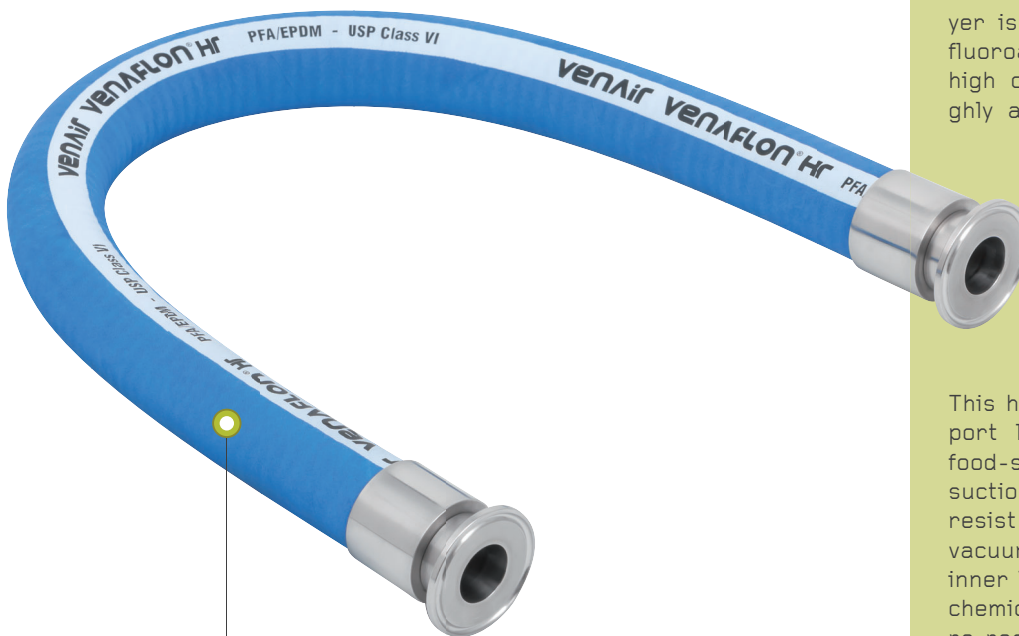

OUTER APPEARANCE:

Blue color and smooth.

APPLICATIONS:

VENAFLO HR is an excellent solution to withstand dynamic stress during the transfer of high purity fluids. It is suitable for use in filling machines and it is externally resistant to the abrasion. The inner layer is made of PFA (Perfluoroalkoxy) which has a high compatibility with highly aggressive chemicals.

This hose is able to transport liquid or semi-liquid food-stuffs by impulsion or suction, since its design can resist either pressure or vacuum. The perfluorinated inner liner ensures utmost chemical and temperature resistance, an excellent impermeability and absolutely hygienic and contamination-free delivery of fluid.

> CERTIFICATIONS OF THE INNER LAYER:

- US FDA Standard 21 CFR 177.1550
- USP Class VI <88> in vivo tests
- USP Class VI <87> in vitro tests
- ISO 10993-5, 10 y 11
- Reg 1935/2004/EEC, and Reg 10/2011/EEC
- Material used is in accordance with EU Directive 2015/863 for Restriction of the use hazardous substances (RoHS 3).

> FABRIC REINFORCEMENT: Yes

> STAINLESS STEEL INSIDE:

Stainless steel wire spring encased inside the hose wall.

> INNER APPEARANCE:

White and smooth.

> MAXIMUM LENGTH OF MANUFACTURE:

20m (65,62ft) with INOX 316L connections (and others under demand).



TEMPERATURE SCALE:

-40°C/+150°C
(-40°F/+302°F)



TECHNICAL TABLE ON PAGE: 44

VENAFLO[®] FULL-X

Conductive PFA hose

VENAFLO[®]: THE BEST SOLUTIONS TO CONVEY AGGRESSIVE PRODUCTS



> MATERIAL:

Synthetic black rubber hose with inner liner of black-colored layer of PFA fluoropolymer in accordance with the main food and pharm certifications.

> CERTIFICATIONS OF THE INNER LAYER:

- US FDA Standard 21 CFR 177.1550
- USP Class VI <88> in vivo tests
- USP Class VI <87> in vitro tests
- ISO 10993-5, 10 y 11
- Reg 1935/2004/EEC, and Reg 10/2011/EEC
- Material used is in accordance with EU Directive 2015/863 for Restriction of the use hazardous substances (RoHS 3).

> ELECTRICAL PROPERTIES:

- ISO 8031:2009 / EN12115 (if is complete with end fittings)
The hose presents a resistivity lower than $10^9 \Omega$.

• Venaflon[®] FULL-X is suitable for its use in ATEX certified zones*

> FABRIC REINFORCEMENT: Yes

> STAINLESS STEEL INSIDE:

Stainless steel wire spring encased inside the hose wall.

> INNER APPEARANCE:

Black and smooth.

> MAXIMUM LENGTH OF MANUFACTURE:

20m (65,62ft) with INOX 316L connections (and others under demand).

APPLICATIONS:

VENAFLO[®] FULL-X is a highly flexible universal hose and its main characteristic is that it is conductive and, therefore, suitable for working areas requiring utmost safety. It is specially recommended for the transport of liquid or semi-liquid fluids, specially, when the chemical products are highly flammable.

This hose is able to transport liquid or semi-liquid food-stuffs by impulsion or suction, since its design can resist either pressure or vacuum. The perfluorinated inner liner ensures utmost chemical and temperature resistance, an excellent impermeability and absolutely hygienic and contamination-free delivery of fluid. The hose is resistant to abrasion, weather, oils and fats.



OUTER APPEARANCE:
Black and smooth.



TEMPERATURE SCALE:

-20°C/+65°C
-4°F/+149°F in accordance with EN 12115:2011



VACUUM RESISTANCE:

0,9 bar (13,05 psi)



TECHNICAL TABLE ON PAGE: 44

*This product can be mounted in ATEX installations (Explosive Atmospheres) which must, in any case, be certified retrospectively by the relevant competent authority.

VITOSIL®

FKM silicone hose



> MATERIAL:

Platinum cured silicone hose with inner liner of white, Class A FKM in accordance with the main food and pharm certifications.

> CERTIFICATIONS OF THE INNER LINER:

- US FDA Standard 21 CFR 177.2600
- Regulation 10/2011/EC and Reg 1935/2004/EC. · Material used is in accordance with EU Directive 2015/863 for Restriction of the use hazardous substances (RoHS 3).

> FABRIC REINFORCEMENT: Yes

Alternatives: all the Vena Sil range of products can be manufactured with an inner layer of FKM.

> STAINLESS STEEL INSIDE:

Stainless steel wire spring encased inside the hose wall.

> INNER APPEARANCE:

White and smooth.

> OUTER APPEARANCE:

White and smooth.

> MAXIMUM LENGTH OF MANUFACTURE:

The standard length of manufacture is 4m (13'). Upon request, 6m length hoses (19' 8") can be manufactured for some diameters.



TEMPERATURE SCALE:

-30°C/+180°C
(-75°F/+356°F)

> APPLICATIONS:

Due to the inner FKM layer it is especially recommended to convey aggressive fluids that are not compatible with silicone. These hoses are able to transport liquid or semi-liquid foodstuffs at high temperatures by impulsion or suction, since their design can resist pressure or vacuum.



VENA® MF-L

Multishape silicone hose



> MATERIAL:

Platinum cured silicone produced in accordance with the main food and pharm certifications.

> CERTIFICATIONS:

- Complete Validation Package. Check page 4.
- Material used is in accordance with EU Directive 2015/863 for Restriction of the use hazardous substances (RoHS 3)

> FABRIC REINFORCEMENT: Yes

> STAINLESS STEEL INSIDE:

Stainless steel wire spring encased inside the hose wall and reinforced couplings to avoid tears or grooves during installation.

> INNER APPEARANCE:

White and completely smooth.

> OUTER APPEARANCE:

White and smooth.

> MAXIMUM LENGTH OF MANUFACTURE: Custom made.

> APPLICATIONS:

Has the attribute of acquiring a certain shape and maintaining

it even under extreme working conditions. It is straight-shape made but can be manually conformed to obtain the desired shape. The hose can be handily moulded in all its area except for the delimited couplings zone. This reference is equipped with INOX 316L couplings which are reinforced twice in order to avoid breaks or grooves on the silicone during installation.



TEMPERATURE SCALE:

-55°C/+180°C
(-67°F/+356°F)



Check out how it works.



ADAPTSIL®

Special silicone shapes



> MATERIAL:

Platinum cured silicone produced in accordance with the main food and pharm certifications.

> CERTIFICATIONS:

- Complete Validation Package. Check page 4.
- Material used is in accordance with EU Directive 2015/863 for Restriction of the use hazardous substances (RoHS 3).

> STAINLESS STEEL INSIDE: No

> OUTER APPEARANCE:

Translucent and smooth.

> INNER APPEARANCE:

Translucent and smooth.

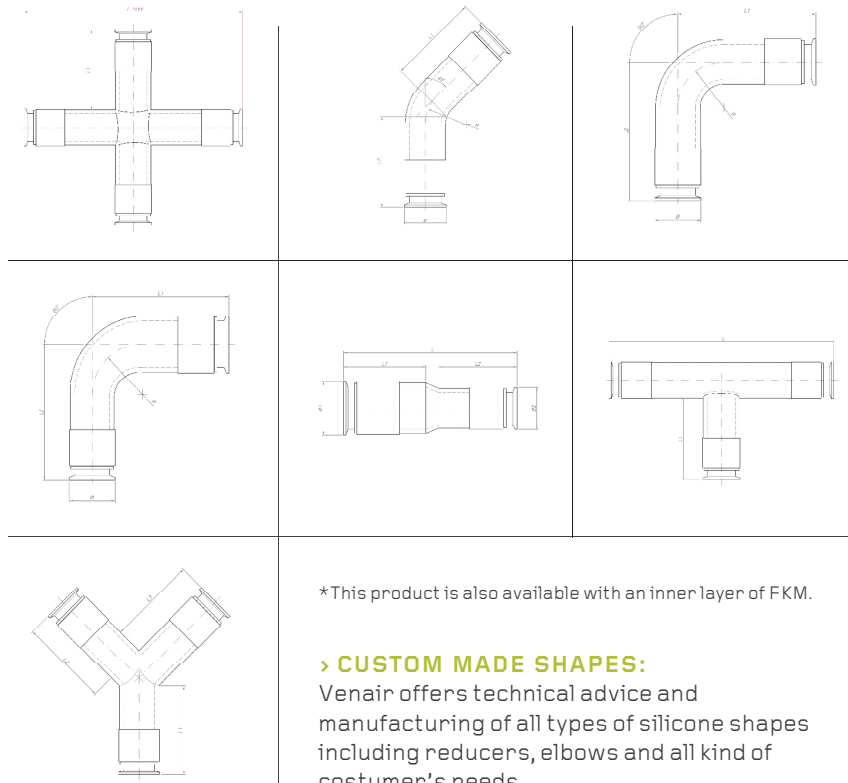

APPLICATIONS:

ADAPTSIL® offers 7 different standard geometrical configurations but we can customize any piece according to the customer's needs. ADAPTSIL® is recommended to:

- Compensate system vibrations as well as to optimize the overall life of the hose or tube connections.
- Solve handling system miss-alignments as well as increased ease in hose or tube installation.
- Offer sound dampening characteristics in your process systems due to its elastic and flexible construction.

*This product is also available with an inner layer of FKM.

> CUSTOM MADE SHAPES:

Venair offers technical advice and manufacturing of all types of silicone shapes including reducers, elbows and all kind of customer's needs.



TEMPERATURE SCALE:

-55°C/+180°C
(-67°F/+356°F)



TECHNICAL TABLE
ON PAGE: 47

SILICONE SLEEVES

Perfect vision of the conveyed product



> MATERIAL:

Platinum cured silicone produced in accordance with the main food and pharm certifications.



TEMPERATURE SCALE:

-55°C / +180°C
(-67°F / +356°F)

> CERTIFICATIONS:

- Complete Validation Package. Check page 4.
- Material used is in accordance with EU Directive 2015/863 for Restriction of the use hazardous substances (RoHS3)

> STAINLESS STEEL INSIDE: No

> INNER APPEARANCE:

Translucent and completely smooth.

> STANDARD CONSTRUCTIONS:

- Sleeve without textile reinforcement with a wall thickness of 1,3mm (+1/-0,5mm) / 0,05 inches (+0,04/-0,002 inches).
- Sleeve with 1 textile reinforcement with a wall thickness of 2,3mm (+1/-0,5mm) / 0,09 inches (+0,04/-0,002 inches).

> MAXIMUM LENGTH OF MANUFACTURE:

4m (13ft), until 6m (19.69ft) under request

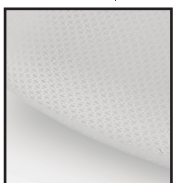

OUTER APPEARANCE:

Translucent and smooth.



APPLICATIONS:

Silicone sleeves are suitable to convey liquids, semi liquids and powders at low pressure (gravity discharge) or protecting against contamination outer-inner or inner-outer in areas of product handling. The high flexibility allows a perfect absorption of vibrations. The translucent aspect allows a visual of the conveyed product.

This product is able to compensate small vibrations and level differences. You can avoid fluid contamination by using a Venair silicone sleeve, e.g. to protect juices from any contact with metallic parts.

PHARMALoader®

Smooth silicone compensator



> MATERIAL:

Platinum cured silicone produced in accordance with the main food and pharm certifications.

> CERTIFICATIONS:

- Complete Validation Package. Check page 4.
- Material used is in accordance with EU Directive 2015/863 for Restriction of the use hazardous substances (RoHS 3)

> FABRIC REINFORCEMENT:

It is made with polyester reinforcements between the silicone layers. To obtain the correct elastic compensation, it is fitted with stainless steel rings, which also prevent volumetric expansion.

> STAINLESS STEEL INSIDE: No

> INNER APPEARANCE:

Translucent and completely smooth.

> OUTER APPEARANCE:

Translucent, and smooth or corrugated.

> MAXIMUM LENGTH OF

MANUFACTURE: Custom made.

> ALTERNATIVES:

- **Pharmaloder HP:** Special construction for high pressure resistance.
- Available with an inner layer of FKM for transport of chemicals.

APPLICATIONS:

PHARMALoader® is an elastic compensator for the pharmaceutical and food industries. This product is a standard element fitted with molded Tri-Clamp seals at the ends of the compensator. The counter-flange elements are made from INOX 304L steel. It is the ideal solution for all tank, hopper, pump and weighing tank outlets to compensate vibrations and level differences. Autoclavable and sterilizable.



CUSTOM-MADE COMPENSATORS:

Venair offers a wide range of silicone compensators which are corrugated in the inside to better withstand vibrations and level differences.



TEMPERATURE SCALE:

-55°C/+180°C
(-67°F/+356°F)



TECHNICAL TABLE
ON PAGE: 40

HEATED HOSE

Electrical heated silicone hose



> MATERIAL:

Platinum cured silicone produced in accordance with the main food and pharm certifications.

> CERTIFICATIONS:

- Complete Validation Package. Check page 4.
- Material used is in accordance with EU Directive 2015/863 for Restriction of the use hazardous substances (RoHS 3)

> CONSTRUCTION:*

Silicone hose equipped with an electrical resistance encased inside the wall in order to provide a regular temperature to the hose for an optimum flow of the conveyed product. Inner cable is connected to an electronic regulator and is also equipped with a PT 100 Ohm gauge connected to the regulator through a cooled end.

> ALTERNATIVES:

This hose can be manufactured without heating up to the ends to maintain high flexibility and lightness.

> FABRIC REINFORCEMENT: Yes

> STAINLESS STEEL INSIDE:

Stainless steel wire spring encased inside the hose wall.

> INNER APPEARANCE:

Translucent and completely smooth.

> MAXIMUM LENGTH OF MANUFACTURE:

Custom made, up to 6m (19,69ft) max.

> VOLTAGE:

220 V or 110V depending on specific user needs.



TEMPERATURE SCALE:

- Operational temperature:
 - 55°C (-67°F)
 - +180°C (356°F)
- Peaks up to +200°C (392°F)

- Set temperature:
 - 0°C (32°F)
 - +200°C (392°F)

APPLICATIONS:

It is specially recommended for applications which needed to ensure a constant temperature to help maintain the flow of the product conducted through it in the food, cosmetic, chemical and pharmaceutical industries. It is suitable for conveying viscous products that needs to maintain a regular temperature during the production process, such as caramel, glycerin or chocolate.

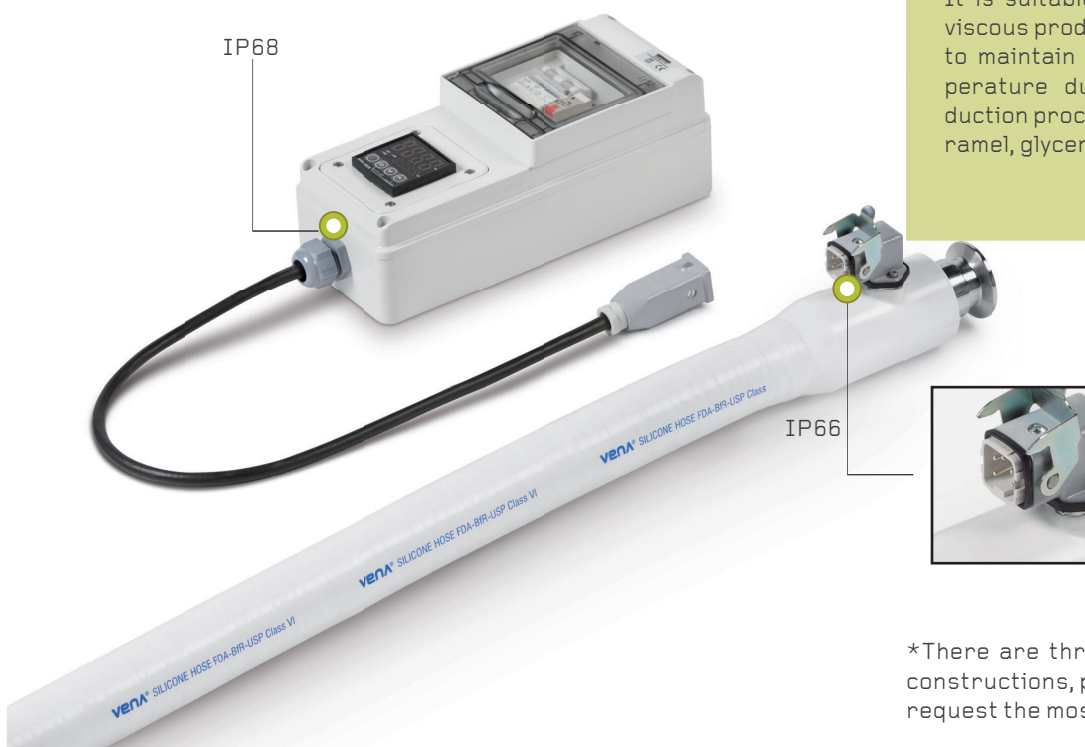

OUTER APPEARANCE:

White and smooth.

*There are three possible constructions, please consult and request the most suitable to your needs.

COOLING HOSE

Spiral tubing rolled along the silicone hose



> MATERIAL:

Platinum cured silicone produced in accordance with the main food and pharm certifications.



OUTER APPEARANCE:
White and convoluted.

APPLICATIONS:

For conveying products that require a stable temperature, this silicone hose is equipped with a cylindrical conduit encased in spiral along the length of the hose. Fittings are assembled on both ends. This system provides a regular temperature of the conveyed product by steam or hot water through the inside of the conduit for heating, and nitrogen or cold water for cooling.

> CERTIFICATIONS:

- Complete Validation Package. Check page 4.
- Material used is in accordance with EU Directive 2015/863 for Restriction of the use hazardous substances (RoHS3)

> **FABRIC REINFORCEMENT:** Yes

> STAINLESS STEEL INSIDE:

Stainless steel wire spring encased inside the hose wall.

> INNER APPEARANCE:

White and completely smooth.

> MAXIMUM LENGTH OF

MANUFACTURE: Custom made.



TEMPERATURE SCALE:

- Operational temperature:
-55°C (-67°F)
+180°C (356°F)

Peaks up to +200°C (392°F)

VENA[®] VIEW

Sight flow indicators



> MATERIAL:

Fluoropolymer hose (PFA or FEP) in accordance with the main food and pharm certifications.



TEMPERATURE SCALE:

-55°C / +180°C
(-67°F / +356°F)

> CERTIFICATIONS:

- USFDA Standard 21CFR177.1550.
- USP Class VI, <88> in vivo test
- ISO 10993, Part 5.
- ResAp 2004 (5), according to Reg 1935/2004/EEC, and Reg 10/2011/EEC.
- Material used is in accordance with EU Directive 2015/863 for Restriction of the use hazardous substances (RoHS 3)

Translucent and completely smooth.

> MAXIMUM LENGTH OF MANUFACTURE:

Under demand (3m/10ft maximum).

> ALTERNATIVES:

This hose can be manufactured with PFA or FEP fluoropolymers or with silicone.



TECHNICAL TABLE ON PAGE: 44

> STAINLESS STEEL INSIDE: No

> INNER APPEARANCE:



OUTER APPEARANCE:

Smooth non-sticky surface.

APPLICATIONS:

Food Grade translucent fluoropolymer with aseptic fittings for applications where visual inspection of the conveyed material is required. It can be mounted in-line and makes it very easy to view product flow in any process or system. FEP/PFA is compatible with many chemical and aggressive products, which makes this product a very resistant and durable option, capable for extended uses.

TELCRA®

Insulating material for
silicone hoses



> MATERIAL:

TELCRA® is an innovative and unique material in the market with excellent insulation characteristics. This material possesses low thermal conductivity and low density, for this reason it can achieve excellent insulation with a low thickness. TELCRA® forms chemical bond with silicone materials. Telcra can be applied in the outer layer of any of Venair products.

> **DENSITY (kg/m³):** 500

> **THICKNESS:** Customizable

> **THERMAL CONDUCTIVITY [W/(m.K)]:** 0.12

> ADVANTAGES

- **ULTRALIGHT:** Lightweight material with a density of 500 kg/m³.
- **EASY INSTALLATION:** Super flexible material. Contours easily to complex forms.
- **ADHESION TO SILICONE:** Telcra® presents an adhesive-free chemical adhesion with silicone materials.
- **ENVIRONMENTALLY SAFE:** Odorless, tasteless and completely non-toxic.

APPLICATIONS:

TELCRA® has the best thermal insulation and a low thermal conductivity for improved efficiency. When the hose is properly installed in the correct thickness, it eliminates condensation problems on cold surfaces. It is suitable for very cold or frozen liquids and semi liquids in the food, pharmaceutical and biotech industries. It also helps to maintain the product temperature inside the hose.



TEMPERATURE SCALE:

-30°C / +180°C
(-22°F / +356°F)



OUTER APPEARANCE:

White and smooth.



Check out
how it works.

VENA[®] TECHNIPUR[®] VAC FDA



> MATERIAL:

Polyurethane in food quality, produced in accordance with the main food and pharm certifications.

High flexible polyurethane hose



APPLICATIONS:

Transparent polyurethane hose recommended for the transport of bulk or powder materials for the food, pharmaceutical and chemical industries. Generally acceptable for pneumatic transport of bulk materials and for vacuum of all types of abrasive particles.



OUTER APPEARANCE:

Translucent and corrugated.

> CERTIFICATIONS:

- US FDA (Foods and Drugs Administration) Standard 21 CFR 177.1680 and CFR 177.2600.
- 1935/2004/EC Regulation and 10/2011/EC (Migration Test).
- Material used is in accordance with EU Directive 2015/863 for Restriction of the use hazardous substances (RoHS 3)

> FABRIC REINFORCEMENT: No

> STAINLESS STEEL INSIDE:

PVC coated steel wire encased inside the walls. Upon request it can be manufactured with stainless steel wire spring.

> INNER APPEARANCE:

Translucent and smooth.

> MAXIMUM LENGTH OF MANUFACTURE: 10 m (33 ft).

> ALTERNATIVES:

VENA TECHNIPUR VAC FDA X: It is recommended for chemical industry and when a low electrical surface resistivity is required. This polyurethane material has an electrical surface resistivity, according to IEC/TS 60079-32-1, of $<10^9$ [$\Omega \cdot m$]. It is manufactured with stainless steel wire encased inside the walls.



TEMPERATURE SCALE:

-20°C / +80°C
(-4°F / +176°F)



TECHNICAL TABLE
ON PAGE: 45

VENA® TECHNIPUR® S100/S200



> MATERIAL:

Food quality polyurethane, produced in accordance with the main food and pharm certifications.

Smooth mandrel-made polyurethane hose

> CERTIFICATIONS:

- US FDA (Foods and Drugs Administration) Standard 21 CFR 177.1680 and CFR 177.2600.
- 1935/2004/EC Regulation and European Council Resolution AP 2004 (5) – silicones and 10/2011/EC (Migration Test).
- Material used is in accordance with EU Directive 2015/863 for Restriction of the use hazardous substances (RoHS3)

> STAINLESS STEEL INSIDE:

Stainless steel wire spring (can be equipped with 316L stainless steel

wire and fittings under demand).

> INNER APPEARANCE:

Translucent and smooth.

> MAXIMUM LENGTH OF MANUFACTURE:

6 m (20 ft) under request.

> ALTERNATIVES:

VENA TECHNIPUR X S100 AND X S200: It is the conductive version which has an electrical surface resistivity of $<10^9$ [$\Omega \cdot m$] according to IEC/TS 60079-32-1.



TEMPERATURE SCALE:

-20°C / +80°C
(-4°F / +176°F)



TECHNICAL TABLE
ON PAGE: 42

OUTER APPEARANCE:

VENA® TECHNIPUR® S200 is translucent and smooth.



OUTER APPEARANCE:

VENA® TECHNIPUR® S100 is translucent and corrugated.

APPLICATIONS:

Recommended for pneumatic transport of bulk materials and for vacuum of all types of abrasive particles.

VENA® ABRASIL

Highly resistant to abrasive particles



> MATERIAL:

New formulation developed by Venair. Special hybrid polymer with polyester fabric reinforcement and a metal wire spiral, everything encased inside the hose.

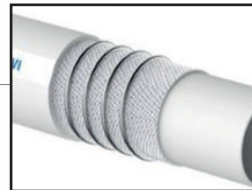

APPLICATIONS

The Vena® Abrasil hose is recommended for suction and transport in food and pharmaceutical industries. Generally acceptable for pneumatic transport of non-flammable bulk materials and suction of all types of abrasive particles.

> CERTIFICATIONS:

- FDA 21 CFR 177.2600. Rubber articles intended for repeated use, FDA ITEM 177.2600(e)
- USP (88) Biological reactivity tests, IN VIVO class V.
- Material used is in accordance with EU Directive 2015/863 for Restriction of the use hazardous substances (RoHS3)

> **FABRIC REINFORCEMENT:** Yes

> **STAINLESS STEEL INSIDE:** No

> **OUTER APPEARANCE:** White and smooth

> **INNER APPEARANCE:** White and smooth

> **MAXIMUM LENGTH OF MANUFACTURE:** 4 m (13.12 ft). In

specific diameters a length of 6 m (19.69 ft)

> **ALTERNATIVES:** Corrugated version for a much higher flexibility.. See technical table on page 43.

> With plastic spiral

> CLEANING PROCESS:

> Can be cleaned by water up to 90°C (194°F)

> Can be sterilized by steam at 120°C(248°F)

> Not recommended for CIP process

> Corrugated version



TEMPERATURE SCALE:

-20°C / +90°C
(-4°F / +194°F) it may reach up to 120°C(248°F) during short period of time



TECHNICAL TABLE ON PAGE: 43

VENA[®] FOOD



> MATERIAL:

EPDM rubber hose with inner layer of butylic rubber in accordance with the main food certifications.

> CERTIFICATIONS OF THE INNER LAYER:

- US FDA (Foods and Drugs Administration) Standard 21 CFR 177.2600.
- 1935/2004/EC Regulation and European Council Resolution AP 2004 (5) – silicones and 10/2011/EC (Migration Test).
- German BfR Standard part XXI Cat 2.
- 3A Sanitary Standard 18-03 Class III.
- Material used is in accordance with EU Directive 2015/863 for Restriction of the use hazardous substances (RoHS 3)

> **FABRIC REINFORCEMENT:** Yes

> STEEL INSIDE:

Steel wire spring encased inside the hose wall.

> OUTER APPEARANCE:

Violet and smooth.

> INNER APPEARANCE:

White and smooth.

> MAXIMUM LENGTH OF MANUFACTURE:

40 meters (131ft).



TEMPERATURE SCALE:

-20°C / +100°C

(-46°F / +212°F)

Peaks up to 130°C (266°F)

for sterilisation (max. 30min)

Butyl rubber hose



APPLICATIONS:

The Vena[®] Food flexible hose is recommended for all types of food products, even at high temperatures (milk, chocolate, drinking water, fruit juice, fresh cream, oil, cosmetic cream, alcohol, etc.). These hoses have a strong, durable construction that can withstand excessive physical handling.



TECHNICAL TABLE

ON PAGE: 40

VENA[®] OIL&FATS



> MATERIAL:

Manufactured with inner NBR rubber and CR cover, it is equipped with plies of synthetic cord reinforcements inside the wall of the hose, with an embedded steel helix wire.

> CERTIFICATIONS:

- US FDA Standard 21 CFR 177.2600
- Material used is in accordance with EU Directive 2015/863 for Restriction of the use hazardous substances (RoHS 3)

> **STAINLESS STEEL INSIDE:** Yes

> **FABRIC REINFORCEMENT:** Yes

> OUTER APPEARANCE:

Green and smooth.

> INNER APPEARANCE:

White and smooth.

> MAXIMUM LENGTH OF MANUFACTURE:

40 meters (131ft).



TEMPERATURE SCALE:

-20°C / +90°C

(-46°F / +194°F)

Peaks up to 130°C (266°F)

for sterilisation (max. 30min)

NBR rubber hose



APPLICATIONS:

Specifically designed to convey milk and liquid fatty foodstuffs. Normally used in dairies, edible oil mills and food processing industries. The high-strength hose structure makes it ideal for unloading operations of milk and milk products and generally for heavy-duty applications.



TECHNICAL TABLE

ON PAGE: 41

VENA[®] STEAM

EPDM rubber hose



> MATERIAL:

This product is manufactured with inner white EPDM food quality rubber and outer blue EPDM cover, it is equipped with plies of synthetic cord reinforcements inside the wall of the tube.

> CERTIFICATIONS OF THE INNER LAYER:

- US FDA Standard 21 CFR 177.2600
- Material used is in accordance with EU Directive 2015/863 for Restriction of the use hazardous substances (RoHS 3)

> FABRIC REINFORCEMENT: Yes

> STEEL INSIDE: No

> OUTER APPEARANCE:

Blue and smooth.

> INNER APPEARANCE:

White and smooth.

> MAXIMUM LENGTH OF MANUFACTURE:

40 meters (131ft).



APPLICATIONS:

Food quality rubber hose, specifically designed for cleaning operations with saturated steam (up to +164°C) and hot water wash-down services.

Normally used in dairy industries, creameries and food processing plants for safe operations during hot water and steam cleaning processes.



TEMPERATURE SCALE:

-40°C / +164°C
(-40°F / +327°F)



TECHNICAL TABLE
ON PAGE: 41

VENA[®] STEAM HR

EPDM rubber hose



> MATERIAL:

EPDM rubber hose with inner layer of food-grade EPDM produced in accordance with the main food and pharm certifications.

> CERTIFICATIONS:

- US FDA Standard 21 CFR 177.2600
- Material used is in accordance with EU Directive 2015/863 for Restriction of the use hazardous substances (RoHS 3)

> STAINLESS STEEL INSIDE:

Embedded stainless steel wire braids.

> FABRIC REINFORCEMENT: Yes

> OUTER APPEARANCE:

Blue and smooth.

> INNER APPEARANCE:

White and smooth.

> MAXIMUM LENGTH OF MANUFACTURE:

20 meters (65,61 ft).



TEMPERATURE SCALE:

-40°C / +164°C
(-40°F / +327°F)



TECHNICAL TABLE
ON PAGE: 41



APPLICATIONS:

It is especially recommended for cleaning operations with saturated steam and hot water wash-down services. The inner liner, specifically compounded to convey hot water and steam allows safe cleaning and disinfection procedures. The outer layer provides good heat-resistance and withstands incidental contact with animal and vegetable fats.

MOLDED CLAMPS

VENAIR® molded silicone clamps are well-suited for critical applications in high purity industries. These assemblies are manufactured with the same raw material than this is used to manufacture hoses and tubing. They reduce installation time (no gaskets), improve cleanliness (no retention zone) and maintain the benefits of the silicone.

VENAIR® molded silicone clamps are available in mini and standard Tri-Clamp fitting styles and are supplied with integrated gaskets molded directly to the face of the clamps. Protective backup cups (thermoplastic or stainless steel) provide a stable clamping surface and safeguard the clamps during installation and use.

- Platinum-cured silicone.
- Completely smooth transition from the tubing or the hose through the clamp.
- Constant diameter. No internal reductions.
- Autoclavable and sterilizable CIP and SIP.
 - Meets USP Class VI, FDA and BfR standards*.
 - Easy installation. Reduces assembly time.
- Temperature resistance: -60°C to 180°C.
 - No product contact with metallic materials.
- Molded clamps can be supplied on any Venair silicone tubing or hose construction.



* Under request, molded assemblies can meet all the certifications set out in the Validation Package.

SZR SYSTEM

(WITHOUT RETENTION ZONE)
AND 3A HOSE ASSEMBLIES

The SZR assembly system ensures a higher level of non-retention in the flexible hoses, as well as greater safety of use. Moreover, our crimped hoses can be Certified according to the 3A Sanitary Standard 62-02 for hose assemblies.

QUALITY OF FINISH

The roughness of the inner surface of the SZR* fittings presents a maximum rugosity of 0.8 microns and can be improved on request. The batch number for the raw material used is indicated on each fitting. All connections are manufactured in a single block, without welds, and the flexed 45° or 90° connections are secured by an orbital weld.

STERILIZATION

ALL FLEXIBLE HOSES MUST BE STERILIZED BEFORE USE AND MUST ONLY BE USED FOR THE INTENDED PURPOSE FOR WHICH THEY WERE DESIGNED.

Our silicone hoses can be sterilized by steam cycles of 30 minutes at a max temperature of 135°C (275°F).

A minimum time of 1 hour must be left between steam cycles for material stabilization. It is recommended an accurate inspection of the hose after 150 hours of sterilization.

It is important to note that steam alters the mechanical and volumetric properties of the silicone elastomer. The product may suffer from the effects of hydrolysis if the sterilization time is exceeded.

Hose replacement criteria based on visual inspection includes among others, displacement of layers, displacement of wire helix from their normal pitch, signs of displacement of fittings or leakage in the ends, reinforcement fabric exposed, wire corrosion, dents, kinks or abrasion marks in both internally and externally.

Other sterilization methods:

- Beta radiation
- Gamma radiation
- Ethylene oxide
- Hydrogen peroxide

ALL THE VENAIR CRIMPED HOSES COUNT WITH THE BATCH NUMBER MARKED IN THE FITTINGS.

Venair also offers other traceability solutions in order to improve the data reading. Various solutions make it possible to obtain all information related to the hose during the manufacturing process, e.g. raw materials, product codes and components, lot number, appropriate certificates, production and sale date and related orders. **The QR code can be marked in any FDA silicone hose. Marking silicone hoses with the QR codes does not distort any characteristic of the hose.** It maintains flexibility, pressure resistance and range of temperature.



> QR MARKING

The QR code assures 100% traceability of the hose. QR code is presented as an alternative to the chip that is commonly used in the market to assure hoses traceability.

- QR code is marked on the silicone with a laser which makes it indelible.
- It does not need any additional software.
- QR code can be read with all kind of mobile device which has downloaded an app to read codes.
- Applications to read QR codes are completely free for any device.
- QR code can provide all kind of information about the product.

- Data content in the code are completely customizable.

> IDENTIFICATION BY COLOR

Labels:

Silicone labels can be placed over any hose in order to mark specific information required by the client. Labels offer clear identification, cleanliness and permanence in the silicone hose.

Venair silicone labels can be customized to meet your specific needs such as part number, manufacturing date, replacement date, or any specific information that you consider to be important.

Features:

- The label is not in contact with the inner liquid.
- It is made of permanent vulcanized silicone.
- Certified free of animal-derived ingredients.
- Handles clean-in-place (CIP) or steam-in-place (SIP) processes.
- Autoclavable.
- More than 15 colors available.



STAINLESS STEEL FITTINGS 316L

Available in 316L stainless steel, with the exception of the nuts and ferrules which are made of 304 stainless steel. Other fittings can be assembled upon request (RJT, FIL, ISS, MACON, GAS JIC, flanges). Clamps and auxiliary parts for welding can also be manufactured.

DIN 11851

DN	A	B (DIN 405)	C
	mm	thread	mm
10	10	28 x 1/8"	10
15	16	34 x 1/8"	15
20	20	44 x 1/6"	20
25	26	52 x 1/6"	25
32	32	58 x 1/6"	32
40	38	65 x 1/6"	38
50	50	78 x 1/6"	50
65	66	95 x 1/6"	63
80	81	110 x 1/4"	75
100	100	130 x 1/4"	102
125	125	160 x 1/4"	127
150	150	190 x 1/4"	152

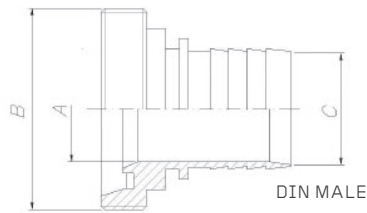
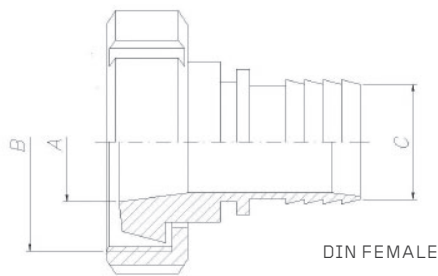

TRI - CLAMP

A	B	C
mm	mm	mm
25	6	6
34	8	8
50	8	8
25	10	10
34	10	10
50	10	10
25	10	13
34	10	13
25	13	13
34	13	13
50	13	13
25	16	16
34	16	16
50	16	16
25	16	20
50	16	20
34	18	18
50	18	18
34	20	20
50	20	20
50	22,5	18
50	22,5	20
50	22,5	25
64	22,5	25
50	29	32
64	32	32
50	35,5	20
50	35,5	25
50	35,5	38
64	35,5	38
64	38	38
64	48,5	50
77	60,3	63
91	72,9	76
119	100	102

SMS

DN	A	B	C
	mm	thread	mm
25	22,5	39,7 x 1/6"	25
38	35,5	59,8 x 1/6"	38
51	48,5	69,8 x 1/6"	50
63	60,5	84,8 x 1/6"	63
76	72,8	97,5 x 1/6"	75
101,6	97,6	132 x 1/6"	102
104	100	124,4 x 1/6"	102

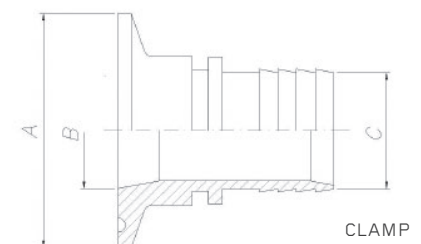
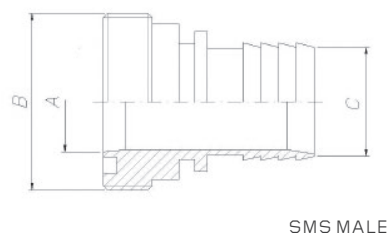
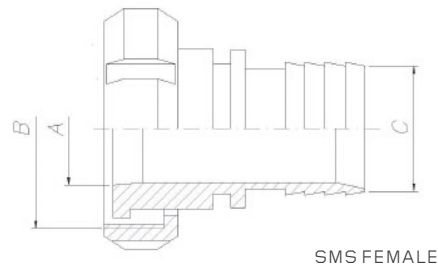

TRI - CLAMP IMPERIAL

DN	A		B		C	
inch	mm	inch	mm	mm	inch	
1/2	25	1	9,5	6,35	1/4	
3/4	25	1	15,8	6,35	1/4	
1/2	25	1	9,5	9,52	3/8	
3/4	25	1	15,8	9,52	3/8	
1/2	25	1	9,5	12,7	1/2	
3/4	25	1	15,8	12,7	1/2	
1/2	25	1	9,5	19,05	3/4	
3/4	25	1	15,8	19,05	3/4	
1	50	2	22,1	6,35	1/4	
1 1/2	50	2	34,8	6,35	1/4	
1	50	2	22,1	9,52	3/8	
1 1/2	50	2	34,8	9,52	3/8	
1	50	2	22,1	12,7	1/2	
1 1/2	50	2	34,8	12,7	1/2	
1	50	2	22,1	19,05	3/4	
1 1/2	50	2	34,8	19,05	3/4	
1	50	2	22,1	25,4	1	
1 1/2	50	2	34,8	25,4	1	
2	64	2 1/2	47,5	25,4	1	
1 1/2	50	2	34,8	38,1	1 1/2	
2	64	2 1/2	47,5	38,1	1 1/2	
2	64	2 1/2	47,5	50,8	2	
2 1/2	77	3	60,2	50,8	2	
2 1/2	77	3	60,2	63,5	2 1/2	
3	91	3 9/16	72,9	63,5	2	
3	91	3 9/16	72,9	76,2	3	
4	119	4 11/16	97,4	101,6	4	

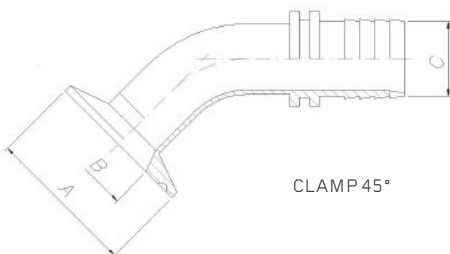
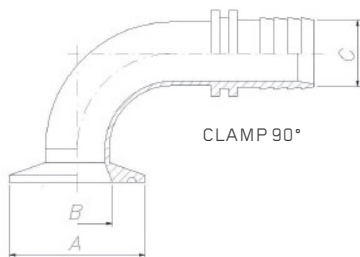

MALE JIC X MALE NPTF ADAPTOR

A MALE JIC	B MALE NPT
7/16	1/4
1/2	1/4
3/4	3/8
7/8	1/2
1 1/16	3/4
1 5/16	1
1 5/8	1 1/4
1 7/8	1 1/2

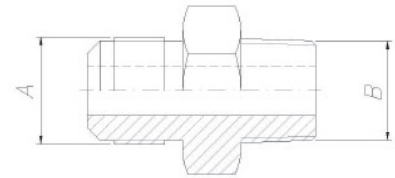

MALE JIC X MALE NPTF ADAPTOR

FEMALE JIC STRAIGHT INSERT

A	B Ø FOR HOSE	
inch	inch	mm
7/16	1/4	6,35
1/2	1/4	6,35
3/4	3/8	9,52
7/8	1/2	12,7
1 1/16	3/4	19,05
1 5/16	1	25,4
1 5/8	1 1/4	31,75
1 7/8	1 1/2	38,1

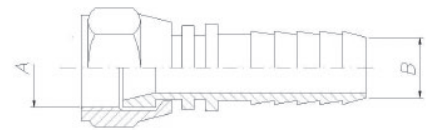

FEMALE JIC STRAIGHT INSERT

MALE JIC X FEMALE NPTF ADAPTOR

A MALE JIC	B MALE NPT
7/16	1/4
1/2	1/4
3/4	3/8
7/8	1/2
1 1/16	3/4
1 5/16	1
1 5/8	1 1/4
1 7/8	1 1/2

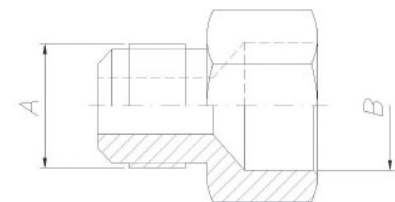

MALE JIC X FEMALE NPTF ADAPTOR

FEMALE JIC ELBOW 45° INSERT

A	B Ø FOR HOSE	
	inch	mm
7/16	1/4	6,35
1/2	1/4	6,35
3/4	3/8	9,52
7/8	1/2	12,7
11/16	3/4	19,05
15/16	1	25,4
15/8	1 1/4	31,75
17/8	1 1/2	38,1

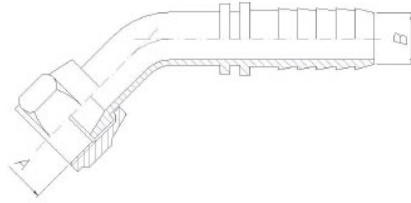

FEMALE JIC ELBOW 45° INSERT

INSERT FEMALE JIC ELBOW 90°

A	B Ø FOR HOSE	
	inch	mm
7/16	1/4	6,35
1/2	1/4	6,35
3/4	3/8	9,52
7/8	1/2	12,7
11/16	3/4	19,05
15/16	1	25,4
15/8	1 1/4	31,75
17/8	1 1/2	38,1

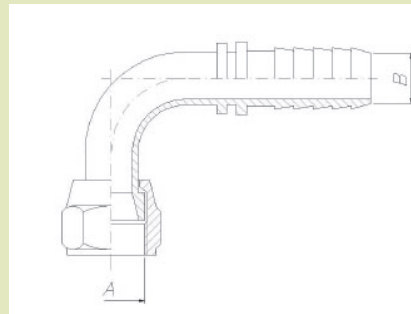

INSERT FEMALE JIC ELBOW 90°

MALE BSP / FEMALE BSP

A	B
thread	mm
1/4"	6
3/8"	8
3/8"	10
1/2"	10
1/2"	13
5/8"	16
3/4"	19
1"	25
1 1/2"	38

INSERT MALE NPT

A	B Ø FOR HOSE	
	inch	mm
7/16	1/4	6,35
1/2	1/4	6,35
3/4	3/8	9,52
7/8	1/2	12,7
11/16	3/4	19,05
15/16	1	25,4
15/8	1 1/4	31,75
17/8	1 1/2	38,1

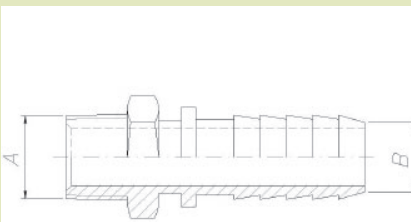

INSERT MALE NPT

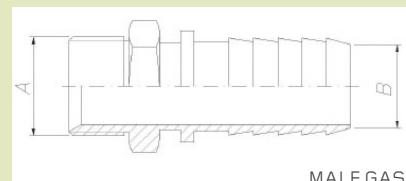

MALE GAS

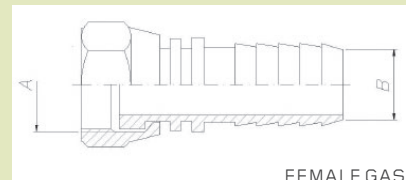

FEMALE GAS

TECHNICAL SPECIFICATIONS

VENA® SIL 630

Ø INT		WALL THICKNESS		WORKING PRESSURE*		BURSTING PRESSURE		BENDING RADIUS	
				ISO 1402/2009		ISO 1402/2009		ISO 1746/2000	
mm	inch	+1/-0.5mm	+0.04/-0.02"	Bar at 20°C	Psi at 68°F	Bar at 20°C	Psi at 68°F	mm	ft
25	1	5,7	0,22	3,9	57	15,7	227	121	0,4
32	1 1/4	5,7	0,22	3,36	49	14,6	211	137	0,45
38	1 1/2	5,7	0,22	3,14	46	14	202	163	0,54
51	2	5,7	0,22	2,4	35	12,1	175	238	0,78
63	2 1/2	5,7	0,22	2,24	33	11,1	161	337	1,11
76	3	5,7	0,22	1,78	26	9,5	138	491	1,61
102	4	5,7	0,22	1	15	6,7	97	557	1,83

* At the indicated working pressure, the hose may experience an elongation up to 20%.
Other diameters can also be manufactured. Please consult.

VENA® SIL 640

Ø INT		WALL THICKNESS		WORKING PRESSURE*		BURSTING PRESSURE	
				ISO 1402/2009		ISO 1402/2009	
mm	inch	+1/-0.5mm	+0.04/-0.02"	Bar at 20°C	Psi at 68°F	Bar at 20°C	Psi at 68°F
6	1/4	4,5	0,18	11,7	169	35	508
10	3/8	4,5	0,18	9,7	140	29	421
13	1/2	4,5	0,18	8,7	126	26	377
19	3/4	4,5	0,18	7,7	111	23	334
25	1	4,5	0,18	6,7	97	20	290
32	1 1/4	4,5	0,18	5,7	82	17	247
38	1 1/2	4,5	0,18	5	73	15	218
51	2	4,5	0,18	4	58	12	174
63	2 1/2	4,5	0,18	3,3	48	10	145
76	3	4,5	0,18	2,7	39	8	116
102	4	4,5	0,18	1,7	24	5	73

* Pressure data hold at room temperature. Please reduce pressure values by 20% for each increase of 100°C / 212°F.
Other diameters can also be manufactured. Please consult.

VENA® SIL 650V

Ø INT		WALL THICKNESS		WORKING PRESSURE*		BURSTING PRESSURE		BENDING RADIUS		VACUUM RESISTANCE
				ISO 1402/2009		ISO 1402/2009		ISO 1746/2000		
mm	inch	+1/-0.5mm	+0.04/-0.02"	Bar at 20°C	Psi at 68°F	Bar at 20°C	Psi at 68°F	mm	inch	
6	1/4	5,5	0,22	26	377	77,9	1130	29	1,14	684 Torr (mmHg) 0,91 bar 13,23 psi 26,93 inHg 9,29 m H ₂ O
10	3/8	5,5	0,22	22	318	65,9	955	34	1,34	
13	1/2	5,5	0,22	19,9	289	59,7	866	39	1,54	
19	3/4	5,5	0,22	16,5	240	49,6	719	54	2,13	
25	1	5,5	0,22	14,8	214	44,3	643	68	2,68	
32	11/4	5,5	0,22	12,8	186	38,5	558	94	3,7	
38	11/2	5,5	0,22	11,5	167	34,5	500	112	4,41	
51	2	5,5	0,22	9,2	133	27,5	399	144	5,67	
63	2 1/2	5,5	0,22	7,5	109	22,6	327	181	7,13	
76	3	6	0,24	6,1	88	18,2	263	232	9,13	
102	4	6	0,24	3,7	54	11,2	163	367	14,45	

* Pressure data hold at room temperature. Please reduce pressure values by 20% for each increase of 100°C / 212°F.
Other diameters can also be manufactured. Please consult.

VENA® SIL 655

Ø INT		WALL THICKNESS		WORKING PRESSURE*		BURSTING PRESSURE		BENDING RADIUS		VACUUM RESISTANCE
				ISO 1402/2009		ISO 1402/2009		ISO 1746/2000		
mm	inch	+1/-0.5mm	+0.04/-0.02"	Bar at 20°C	Psi at 68°F	Bar at 20°C	Psi at 68°F	mm	inch	
6	1/4	5,5	0,26	31,5	456	94,5	1370	43	1,69	684 Torr (mmHg) 0,91 bar 13,23 psi 26,93 inHg 9,29 m H ₂ O
10	3/8	5,5	0,26	27	392	81	1174	49	1,93	
13	1/2	5,5	0,26	24,5	355	73,5	1066	54	2,13	
19	3/4	5,5	0,26	20,5	297	61,5	892	68	2,68	
25	1	5,5	0,26	18,5	268	55,5	805	80	3,15	
32	11/4	5,5	0,26	16,5	239	49,5	718	100	3,94	
38	11/2	6,5	0,28	15	218	45	653	121	4,76	
51	2	6,5	0,28	12	174	36	522	185	7,28	
63	2 1/2	6,5	0,28	10	145	30	435	273	10,75	
76	3	6,5	0,28	7,1	103	21,3	308	318	12,52	
102	4	6,5	0,28	5	73	15	218	423	16,65	

* Pressure data hold at room temperature. Please reduce pressure values by 20% for each increase of 100°C / 212°F.
Other diameters can also be manufactured. Please consult.

VENA® SIL 650V LASTIC

Ø INT		WALL THICKNESS		WORKING PRESSURE*		BURSTING PRESSURE		BENDING RADIUS	
				ISO 1402/2009		ISO 1402/2009		ISO 1746/2000	
mm	inch	+1/-0.5 mm	+0.04/-0.02	Bar at 20°C	Psi at 68°F	Bar at 20°C	Psi at 68°F	mm	inch
6	1/4	5.5	0.22	23.5	340.7	70.5	1022.1	15	0.6
8	5/16	5.5	0.22	21.4	310.3	64.2	931.0	15	0.6
10	3/8	5.5	0.22	19.8	286.8	59.3	860.3	15	0.6
13	1/2	5.5	0.22	17.9	259.1	53.6	777.2	15	0.6
16	5/8	5.5	0.22	16.3	237.1	49.0	711.4	15	0.6
19	3/4	5.5	0.22	15.1	219.0	45.3	657.0	15	0.6
22	7/8	5.5	0.22	14.0	203.5	42.1	610.5	15	0.6
25	1	5.5	0.22	13.1	190.0	39.3	570.0	25	1.0
32	1 1/4	5.5	0.22	11.3	163.9	33.9	491.8	49	1.9
38	1 1/2	5.5	0.22	10.1	145.8	30.2	437.4	69	2.7
51	2	5.5	0.22	7.9	114.7	23.7	344.1	114	4.5
63	2 1/2	5.5	0.22	6.4	92.4	19.1	277.2	155	6.1
76	3	6.0	0.24	5.0	72.6	15.0	217.8	200	7.9
102	4	6.0	0.24	2.9	41.5	8.6	124.6	290	11.4

* Pressure data hold at room temperature. Please reduce pressure values by 20% for each increase of 100°C / 212°F. Other diameters can also be manufactured. Please consult.

VENA® SIL 650V PLASTIC

Ø INT		WALL THICKNESS		WORKING PRESSURE*		BURSTING PRESSURE		BENDING RADIUS	
				ISO 1402/2009		ISO 1402/2009		ISO 1746/2000	
mm	inch	+1/-0.5 mm	+0.04/-0.02	Bar at 20°C	Psi at 68°F	Bar at 20°C	Psi at 68°F	mm	inch
6	1/4	6	0.24	26.0	376.5	77.9	1129.5	29	1.14
8	5/16	6	0.24	24.0	348.1	72.0	1044.3	31	1.22
10	3/8	6	0.24	22.0	318.4	65.9	955.3	34	1.34
13	1/2	6	0.24	19.9	288.6	59.7	865.8	45	1.77
16	5/8	6	0.24	18.3	265.0	54.8	794.9	55	2.15
19	3/4	6	0.24	16.5	239.6	49.6	718.8	68	2.69
22	7/8	6	0.24	15.8	228.8	47.3	686.3	82	3.24
25	1	6	0.24	14.8	214.2	44.3	642.7	105	4.13
32	1 1/4	6	0.24	12.8	186.2	38.5	558.5	131	5.15
38	1 1/2	6	0.24	11.5	166.6	34.5	499.9	166	6.52
51	2	6	0.24	9.2	133.2	27.5	399.5	231	9.08
63	2 1/2	6	0.24	7.5	109.1	22.6	327.4	299	11.77
76	3	0.26	0.26	6.1	87.8	18.2	263.4	378	14.88
102	4	0.26	0.26	3.7	54.3	11.2	163.0	550	21.67

* Pressure data hold at room temperature. Please reduce pressure values by 20% for each increase of 100°C / 212°F. Other diameters can also be manufactured. Please consult.

VENA® TECHNOSIL

Ø INT		OUTER DIAMETER		WORKING PRESSURE*		BURSTING PRESSURE		BENDING RADIUS	
				ISO 1402/2009		ISO 1402/2009		ISO 1746/2000	
mm	inch	mm	inch	Bar at 20°C	Psi at 68°F	Bar at 20°C	Psi at 68°F	mm	inch
6,35	1/4	13,2	0,52	9,3	135	28	406	40	0,13
7,93	5/16	15	0,59	7,7	111	23	334	45	0,15
9,52	3/8	16,6	0,65	7	102	21	305	55	0,18
12,7	1/2	20,3	0,8	5,7	82	17	247	70	0,23
15,88	5/8	24,5	0,96	4,3	63	13	189	85	0,28
19,05	3/4	27,9	1,1	3,7	53	11	160	95	0,31
22,22	7/8	31,3	1,23	3,3	48	10	145	110	0,36
25,4	1	34,5	1,36	3	44	9	131	135	0,44
31,75	1 1/4	40,8	1,61	2,3	34	7	102	220	0,74

* Pressure data hold at room temperature. Please reduce pressure values by 20% for each increase of 100°C / 212°F.
Other sizes available under demand.

VENA® TECHNOSIL DB

Ø INT		OUTER DIAMETER		WORKING PRESSURE*		BURSTING PRESSURE		BENDING RADIUS		VACUUM PRESSURE	
				ISO 1402/2009		ISO 1402/2009		ISO 1746/2000			
mm	inch	mm	inch	Bar at 20°C	Psi at 68°F	Bar at 20°C	Psi at 68°F	mm	inch	Bar	Psi
6,35	1/4	16	0,63	23,7	344	71,2	1033	34	1,36	1	14,5
7,93	5/16	18	0,71	22,8	331	68,5	994	37	1,48	1	14,5
9,52	3/8	20	0,79	22,3	324	66,9	971	46	1,84	0,95	13,78
12,7	1/2	23	0,91	19,4	282	58,3	846	51	2,04	0,95	13,78
15,88	5/8	27	1,06	17	246	50,9	739	65	2,6	0,9	13,05
19,05	3/4	30,5	1,2	15,6	226	46,8	678	76	3,04	0,8	11,6
22,22	7/8	33	1,3	14	202	41,9	607	99	3,96	0,5	7,25
25,4	1	37	1,46	12,5	181	37,5	544	118	4,72	0,4	5,8
28,00	1 7/64	38	1,50	11,67	169,21	35,00	507,64	160,00	6,40	0,15	2,18
31,75	1 1/4	46	1,81	10,07	146,01	30,20	438,02	181,00	7,24	0,15	2,18

* Pressure data hold at room temperature. Please reduce pressure values by 20% for each increase of 100°C / 212°F.
Other sizes available under demand.

VENA® BIO PURE

INNER DIAMETER		OUTER DIAMETER	
mm	inch	mm	inch
1,6	1/16	4,8	3/16
2,4	3/32	5,6	7/32
3,2	1/8	6,4	1/4
3,2	1/8	7,9	5/16
3,2	1/8	9,5	3/8
4,8	3/16	7,9	5/16
4,8	3/16	9,5	3/8
4,8	3/16	11,1	7/16
6,4	1/4	9,5	3/8
6,4	1/4	12,7	1/2
7,9	5/16	12,7	1/2
9,6	3/8	14,3	9/16
9,5	3/8	15,9	3/8
11,1	7/16	14,3	9/16
12,7	1/2	19,0	3/4
15,9	5/8	22,2	7/8
19,0	3/4	25,4	1

Other sizes available under demand.

PHARMALoader®

NOMINAL CLAMP Ø	CLAMP HEAD Ø	INNER Ø	OVERALL LENGHT		WORKING PRESSURE	
inch	mm	mm	inch	mm	Bar	Psi
1	50,5	22,1	4	102	1,00	14
1 1/2	50,5	34,7	4	102	0,90	13
2	64	47,5	4	102	0,80	11
2 1/2	77,5	60	4	102	0,70	10
3	91	73	6	152	0,60	8
4	119	97,6	6	152	0,50	7
5	155	125	7	178	0,40	5
6	183	150	7	178	0,35	5
6	167	147	7	178	0,35	5
8	233,5	200	7	178	0,20	3
8	218	198	7	178	0,20	3
10	270	250	8	204	0,10	1

PHARMALoader HP®

NOMINAL CLAMP Ø	CLAMP HEAD Ø	INNER Ø	OVERALL LENGHT	WORKING PRESSURE	BURSTING PRESSURE
inch	mm	mm	mm(inches)	Bar	Bar
1 1/2"	50.5	34.7	4" (102)	5.7	17
2"	64	47.5	4" (102)	4.0	12
3"	91	73.0	6" (152)	2.6	7.9

VENA® FOOD

INNER DIAMETER		OUTER DIAMETER		BENDING RADIUS		WORKING PRESSURE		BURSTING PRESSURE	
mm	inch	mm	inch	mm	inch	Bar at 20°C	Psi at 68°F	Bar at 20°C	Psi at 68°F
16	5/8	26	1	96	3,78	10	145	30	435
19	3/4	29	1 1/8	115	4,53	10	145	30	435
25	1	37	2 1/6	150	5,91	10	145	30	435
32	1 1/4	45	1 3/4	200	7,87	10	145	30	435
38	1 1/2	51	2	230	9,06	10	145	30	435
51	2	65	2 9/16	300	11,81	10	145	30	435
63	2 1/2	78	3 1/6	380	14,96	10	145	30	435
76	3	92	3 5/8	450	17,72	10	145	30	435
102	4	120	4 3/4	600	23,62	10	145	30	435

VENA® OIL&FATS

INNER DIAMETER		WALL THICKNESS		WORKING PRESSURE		BURSTING PRESSURE		BENDING RADIUS	
mm	inch	+1/ -0.5 mm	+0.04/-0.02 inch	Bar at 20°C	Psi at 68°F	Bar at 20°C	Psi at 68°F	mm	inch
19	3/4	6,00	0,24	10	145	30	435	80	3,15
25	1	6,00	0,24	10	145	30	435	120	4,73
32	1 1/4	6,00	0,24	10	145	30	435	150	5,91
38	1 1/2	7,00	0,28	10	145	30	435	200	7,88
40	1 37/64	7,00	0,28	10	145	30	435	200	7,88
45	1 49/64	7,00	0,28	10	145	30	435	225	8,86
50	1 31/32	7,00	0,28	10	145	30	435	250	9,85
52	2 3/64	7,00	0,28	10	145	30	435	280	11,03
60	2 23/64	8,00	0,32	10	145	30	435	330	13,00
65	2 9/16	8,00	0,32	10	145	30	435	360	14,18
70	2 3/4	8,00	0,32	10	145	30	435	420	16,54
75	2 61/64	9,00	0,36	10	145	30	435	450	17,72
80	3 5/32	9,00	0,36	10	145	30	435	480	18,90
100	3 15/16	9,00	0,36	10	145	30	435	600	23,63

VENA® STEAM / STEAM HR

INNER DIAMETER		WALL THICKNESS ISO 1307				WORKING PRESSURE ISO 1402		BURSTING PRESSURE ISO 1402		BENDING RADIUS ISO 1746			
		+1.5/ -1.5 MM		+0.06/-0.06 INCH						MM		INCH	
mm	inch	STEAM	STEAM HR	STEAM	STEAM HR	Bar at 20°C	Psi at 68°F	Bar at 164°C	Psi at 327°F	STEAM	STEAM HR	STEAM	STEAM HR
10	3/8	5,00	5,00	0,20	0,20	6	87,02	18	261,07	75	66	2,96	2,60
13	1/2	5,00	6,00	0,20	0,24	6	87,02	18	261,07	100	86	3,94	3,39
16	5/8	6,00	6,00	0,24	0,24	6	87,02	18	261,07	120	106	4,73	4,17
19	3/4	6,00	7,00	0,24	0,27	6	87,02	18	261,07	160	125	6,30	4,92
25	1	7,00	7,50	0,28	0,30	6	87,02	18	261,07	200	165	7,88	6,50
32	1 1/4	7,00	7,50	0,28	0,30	6	87,02	18	261,07	260	190	10,24	7,48
38	1 1/2	8,00	8,50	0,31	0,33	6	87,02	18	261,07	300	225	11,82	8,86
50	2	8,50	9,00	0,35	0,35	6	87,02	18	261,07	380	305	14,96	12,01

VENA® TECHNIPUR® S100

INNER DIAMETER		WALL THICKNESS		WORKING PRESSURE		BURSTING PRESSURE	
				ISO 1402/2009		ISO 1402/2009	
mm	inch	+1/ -0.5 mm	+0.04/ -0.02 inch	Bar at 20°C	Psi at 68°F	Bar at 20°C	Psi at 68°F
20	0,79	3,6	0,14	10,73	155,51	32,18	466,54
25	0,98	3,6	0,14	9,75	141,43	29,26	424,29
30	1,18	3,6	0,14	8,83	128,02	26,49	384,06
32	1,26	3,6	0,14	8,47	122,85	25,42	368,54
35	1,38	3,6	0,14	7,95	115,29	23,85	345,87
38	1,5	3,6	0,14	7,45	107,98	22,34	323,93
40	1,57	3,6	0,14	7,12	103,24	21,36	309,71
45	1,77	3,6	0,14	6,34	91,86	19,01	275,58
51	2,01	3,6	0,14	5,46	79,1	16,37	237,3
60	2,36	3,6	0,14	4,26	61,79	12,78	185,36
63,5	2,5	3,6	0,14	3,84	55,64	11,51	166,93
70	2,76	3,6	0,14	3,11	45,12	9,34	135,36
76	2,99	3,6	0,14	2,51	36,42	7,54	109,26
82	3,23	3,6	0,14	1,98	28,69	5,94	86,08
90	3,54	3,6	0,14	1,37	19,91	4,12	59,73
102	4,02	3,6	0,14	0,69	9,98	2,06	29,94
114	4,49	3,6	0,14	0,27	3,95	0,82	11,84
127	5	3,6	0,14	0,12	1,81	0,37	5,43
152	5,98	3,6	0,14	N/A	N/A	N/A	N/A
180	7,09	3,6	0,14	N/A	N/A	N/A	N/A

VENA® TECHNIPUR® S200

INNER DIAMETER		WALL THICKNESS		WORKING PRESSURE		BURSTING PRESSURE	
mm	inch	+1/-0.5 mm	+0.04/-0.02 inch	ISO 1402/2009 Bar at 20°C	ISO 1402/2009 Psi at 68°F	ISO 1402/2009 Bar at 20°C	ISO 1402/2009 Psi at 68°F
13,00	0,51	4,50	0,18	12,17	176,47	36,50	529,25
16,00	0,63	4,50	0,18	11,54	167,33	34,61	501,84
20	0,79	4,50	0,18	10,73	155,51	32,18	466,54
25	0,98	4,50	0,18	9,75	141,43	29,26	424,29
30	1,18	4,50	0,18	8,83	128,02	26,49	384,06
32	1,26	4,50	0,18	8,47	122,85	25,42	368,54
35	1,38	4,50	0,18	7,95	115,29	23,85	345,87
38	1,5	4,50	0,18	7,45	107,98	22,34	323,93

VENA® ABRASIL

INNER DIAMETER		WALL THICKNESS		WORKING PRESSURE		BURSTING PRESSURE		BENDING RADIUS	
				ISO 1402/2009		ISO 1402/2009		ISO 1746	
mm	inch	+1/ -0.5 mm	+0.04/ -0.02 inch	Bar at 20°C	Psi at 68°F	Bar at 20°C	Psi at 68°F	mm	inch
6	1/4	5.0	0.20	14.5	210.3	43.5	630.9	28.6	1.13
10	3/8	5.0	0.20	13.7	199.3	41.2	598.0	34.4	1.35
13	1/2	5.0	0.20	13.2	191.3	39.6	574.0	39.1	1.54
16	5/8	5.0	0.20	12.7	183.5	38.0	550.6	44.3	1.74
19	3/4	5.0	0.20	12.1	175.9	36.4	527.7	49.7	1.96
22	7/8	5.0	0.20	11.6	168.5	34.8	505.4	55.6	2.19
25	1	5.0	0.20	11.1	161.2	33.3	483.7	61.8	2.43
32	1 1/4	5.0	0.20	10.0	145.1	30.0	435.2	77.7	3.06
38	1 1/2	5.0	0.20	9.1	132.0	27.3	396.0	92.9	3.66
51	2	5.0	0.20	7.3	106.3	22.0	318.9	130.8	5.15
63	2 1/2	5.0	0.20	5.9	85.7	17.7	257.2	171.8	6.76
76	3	5.5	0.22	4.6	66.8	13.8	200.4	222.8	8.77
102	4	5.5	0.22	2.7	39.6	8.2	118.7	345.2	13.59

VENA® ABRASIL PL

INNER DIAMETER		WALL THICKNESS		WORKING PRESSURE		BURSTING PRESSURE		BENDING RADIUS ISO 1746	
				ISO 1402/2009		ISO 1402/2009			
mm	inch	+1/-0.5mm	+0.04/- 0.02 inch	Bar at 20°C	Psi at 68°F	Bar at 20°C	Psi at 68°F	mm	inch
6	1/4	5.0	0.20	10.5	152.5	31.6	457.6	24.6	0.97
8	5/16	5.0	0.20	9.5	138.0	28.5	413.9	25.2	0.99
10	3/8	5.0	0.20	8.7	126.6	26.2	379.9	25.9	1.02
13	1/2	5.0	0.20	7.8	113.3	23.4	340.0	27.1	1.07
16	5/8	5.0	0.20	7.1	102.8	21.3	308.4	28.4	1.12
19	3/4	5.0	0.20	6.5	94.1	19.5	282.3	29.9	1.18
22	7/8	5.0	0.20	6.0	86.7	17.9	260.0	31.5	1.24
25	1	5.0	0.20	5.5	80.2	16.6	240.6	33.3	1.31
32	1 1/4	5.0	0.20	4.7	67.7	14.0	203.0	38.1	1.50
38	1 1/2	5.0	0.20	4.1	59.0	12.2	176.9	42.9	1.69
51	2	5.5	0.20	3.0	44.1	9.1	132.2	55.5	2.18
63	2 1/2	5.0	0.20	2.3	33.3	6.9	100.0	115.4	4.54
76	3	5.5	0.22	1.6	23.8	4.9	71.5	194.8	7.67
102	4	5.5	0.22	0.6	8.9	1.8	26.7	425.9	16.77

VENAFLO[®] HR

INNER DIAMETER		WALL THICKNESS		WORKING PRESSURE		BENDING RADIUS	
mm	inch	+1/ -0.5 mm	+0.04/-0.02 inch	ISO 1402/2009 Bar at 20°C	ISO 1402/2009 Psi at 68°F	ISO 1746/1998 mm	ISO 1746/1998 inch
13	1/2	6	0,24	10	145	60	2,4
16		6	0,24	10	145	75	2,9
19	3/4	6	0,24	10	145	90	3,5
25	1	6	0,24	10	145	140	5,5
32	1 1/4	6,5	0,26	10	145	200	7,8
38	1 1/2	6,5	0,26	10	145	250	9,8
51	2	7,25	0,28	10	145	300	11,8
63,5	2,5	8	0,31	10	145	380	14,9
76	3,00	8	0,31	10	145	500	19,6
100	3,9	8,5	0,33	10	145	600	24

VENAFLO[®] FULL-X

INNER DIAMETER		WALL THICKNESS		WORKING PRESSURE ISO 1402/2009		BENDING RADIUS ISO 1746/1998	
mm	inch	+1/ -0.5 mm	+0.04/-0.02 inch	Bar at 20°C	Psi at 68°F	mm	inch
13	1/2	6	0,24	10	145,04	135	5,31
19	3/4	6	0,24	10	145,04	188	7,40
25	1	6	0,24	10	145,04	225	8,85
32	1 1/4	6,5	0,26	10	145,04	262	10,31
38	1 1/2	6,5	0,26	10	145,04	338	13,30
51	2	7,25	0,28	10	145,04	412	16,22
63,5	2 1/2	8	0,31	10	145,04	450	17,71
76	3	8	0,31	10	145,04	525	20,66
100	4	8,5	0,33	10	145,04	700	27,56

VENA[®] VIEW

INNER DIAMETER		WORKING PRESSURE		BURSTING PRESSURE		WORKING PRESSURE WITH HOUSING		BURSTING PRESSURE WITH HOUSING	
mm	inch	Bar	Psi	Bar	Psi	Bar	Psi	Bar	Psi
25	0,98	8	116	32	464	12	174	48	696
51	2	5	72	22	319	10	145	47	681
63	2,48	5	72	22	319	10	145	40	580
76	2,99	5	72	20	290	9	130	36	522
102	4,02	4	58	16	232	7	101	14	203

VENA® TECHNIPUR® VAC FDA

INNER DIAMETER		WALL THICKNESS		WORKING PRESSURE		BURSTING PRESSURE		VACUUM RESISTANCE		BENDING RADIUS	
				ISO 1402/2009		ISO 1402/2009		ISO 7233/2006		ISO 1746/2000	
mm	inch	+0.04/ -0.02 mm	+1.57x10 ⁻³ / -7.87x10 ⁻⁴ inch	Bar a 20°C	Psi a 68F	Bar a 20°C	Psi a 68F	Bar a 20°C	Psi a 68F	mm	inch
50	1.97	1,20	0,05	2,07	30,02	6,21	90,05	0,61	8,85	85	0,28
55	2.17	1,20	0,05	1,87	27,12	5,61	81,35	0,55	7,98	93	0,31
60	2.36	1,20	0,05	1,71	24,80	5,13	74,39	0,51	7,40	100	0,33
65	2.56	1,20	0,05	1,58	22,91	4,74	68,73	0,47	6,82	108	0,35
70	2.76	1,20	0,05	1,46	21,17	4,38	63,51	0,43	6,24	115	0,38
75	2.95	1,20	0,05	1,36	19,72	4,08	59,16	0,4	5,80	123	0,40
80	3.15	1,20	0,05	1,28	18,56	3,84	55,68	0,38	5,51	130	0,43
85	3.35	1,20	0,05	1,2	17,40	3,60	52,20	0,36	5,22	138	0,45
90	3.54	1,20	0,05	1,13	16,39	3,39	49,16	0,34	4,93	145	0,48
95	3.74	1,20	0,05	1,07	15,52	3,21	46,55	0,32	4,64	153	0,50
100	3.94	1,20	0,05	1,01	14,65	3,03	43,94	0,3	4,35	160	0,52
105	4.13	1,20	0,05	0,96	13,92	2,88	41,76	0,29	4,21	168	0,55
110	4.33	1,20	0,05	0,92	13,34	2,76	40,02	0,27	3,92	175	0,57
115	4.53	1,20	0,05	0,88	12,76	2,64	38,28	0,26	3,77	183	0,60
120	4.72	1,20	0,05	0,84	12,18	2,52	36,54	0,25	3,63	190	0,62
125	4.92	1,20	0,05	0,81	11,75	2,43	35,24	0,24	3,48	198	0,65
130	5.12	1,20	0,05	0,77	11,17	2,31	33,50	0,23	3,34	205	0,67
135	5.31	1,20	0,05	0,75	10,88	2,25	32,63	0,22	3,19	213	0,70
140	5.51	1,20	0,05	0,72	10,44	2,16	31,32	0,22	3,19	220	0,72
145	5.71	1,20	0,05	0,69	10,01	2,07	30,02	0,21	3,05	228	0,75
150	5.91	1,20	0,05	0,67	9,72	2,01	29,15	0,2	2,90	235	0,77
155	6.10	1,20	0,05	0,65	9,43	1,95	28,28	0,19	2,76	243	0,80
160	6.30	1,20	0,05	0,63	9,14	1,89	27,41	0,19	2,76	250	0,82
165	6.50	1,20	0,05	0,61	8,85	1,83	26,54	0,18	2,61	258	0,85
170	6.69	1,20	0,05	0,59	8,56	1,77	25,67	0,18	2,61	265	0,87
175	6.89	1,20	0,05	0,57	8,27	1,71	24,80	0,17	2,47	273	0,90
180	7.09	1,20	0,05	0,55	7,98	1,65	23,93	0,17	2,47	280	0,92
185	7.28	1,20	0,05	0,54	7,83	1,62	23,49	0,16	2,32	288	0,94
190	7.48	1,20	0,05	0,52	7,54	1,56	22,62	0,16	2,32	295	0,97
195	7.68	1,20	0,05	0,51	7,40	1,53	22,19	0,15	2,18	303	0,99
200	7.87	1,20	0,05	0,5	7,25	1,50	21,75	0,15	2,18	310	1,02
205	8.07	1,20	0,05	0,49	7,11	1,47	21,32	0,15	2,18	318	1,04
210	8.27	1,20	0,05	0,47	6,82	1,41	20,45	0,14	2,03	325	1,07
215	8.46	1,20	0,05	0,46	6,67	1,38	20,01	0,14	2,03	333	1,09
220	8.66	1,20	0,05	0,45	6,53	1,35	19,58	0,14	2,03	340	1,12
225	8.86	1,20	0,05	0,44	6,38	1,32	19,14	0,13	1,89	348	1,14
230	9.06	1,20	0,05	0,43	6,24	1,29	18,71	0,13	1,89	355	1,16

›Continued on the next page.

INNER DIAMETER		WALL THICKNESS		WORKING PRESSURE		BURSTING PRESSURE		VACUUM RESISTANCE		BENDING RADIUS	
				ISO 1402/2009		ISO 1402/2009		ISO 7233/2006		ISO 1746/2000	
mm	inch	+0.04/ -0.02 mm	+1.57x10 ⁻³ / -7.87x10 ⁻⁴ inch	Bar a 20°C	Psi a 68F	Bar a 20°C	Psi a 68F	Bar a 20°C	Psi a 68F	mm	inch
235	9,25	1,20	0,05	0,42	6,09	1,26	18,27	0,13	1,89	363	1,19
240	9,45	1,20	0,05	0,41	5,95	1,23	17,84	0,13	1,89	370	1,21
245	9,65	1,20	0,05	0,4	5,80	1,20	17,40	0,12	1,74	378	1,24
250	9,84	1,20	0,05	0,4	5,80	1,20	17,40	0,12	1,74	385	1,26
255	10,04	1,20	0,05	0,39	5,66	1,17	16,97	0,12	1,74	393	1,29
260	10,24	1,20	0,05	0,38	5,51	1,14	16,53	0,12	1,74	400	1,31
265	10,43	1,20	0,05	0,37	5,37	1,11	16,10	0,11	1,60	408	1,34
270	10,63	1,20	0,05	0,37	5,37	1,11	16,10	0,11	1,60	415	1,36
275	10,83	1,20	0,05	0,36	5,22	1,08	15,66	0,11	1,60	423	1,39
280	11,02	1,20	0,05	0,35	5,08	1,05	15,23	0,11	1,60	430	1,41
285	11,22	1,20	0,05	0,35	5,08	1,05	15,23	0,11	1,60	438	1,44
290	11,42	1,20	0,05	0,34	4,93	1,02	14,79	0,1	1,45	445	1,46
295	11,61	1,20	0,05	0,33	4,79	0,99	14,36	0,1	1,45	453	1,49
300	11,81	1,20	0,05	0,33	4,79	0,99	14,36	0,1	1,45	460	1,51
305	12,01	1,20	0,05	0,32	4,64	0,96	13,92	0,1	1,45	468	1,54
310	12,20	1,20	0,05	0,32	4,64	0,96	13,92	0,1	1,45	475	1,56
315	12,40	1,20	0,05	0,31	4,50	0,93	13,49	0,1	1,45	483	1,58
320	12,60	1,20	0,05	0,31	4,50	0,93	13,49	0,09	1,31	490	1,61
325	12,80	1,20	0,05	0,3	4,35	0,90	13,05	0,09	1,31	498	1,63
330	12,99	1,20	0,05	0,3	4,35	0,90	13,05	0,09	1,31	505	1,66
335	13,19	1,20	0,05	0,29	4,21	0,87	12,62	0,09	1,31	513	1,68
340	13,39	1,20	0,05	0,29	4,21	0,87	12,62	0,09	1,31	520	1,71
345	13,58	1,20	0,05	0,28	4,06	0,84	12,18	0,09	1,31	528	1,73
350	13,78	1,20	0,05	0,28	4,06	0,84	12,18	0,09	1,31	535	1,75
355	13,98	1,20	0,05	0,28	4,06	0,84	12,18	0,08	1,16	543	1,78
360	14,17	1,20	0,05	0,27	3,92	0,81	11,75	0,08	1,16	550	1,80
365	14,37	1,20	0,05	0,27	3,92	0,81	11,75	0,08	1,16	558	1,83
370	14,57	1,20	0,05	0,26	3,77	0,78	11,31	0,08	1,16	565	1,85
375	14,76	1,20	0,05	0,26	3,77	0,78	11,31	0,08	1,16	573	1,88
380	14,96	1,20	0,05	0,26	3,77	0,78	11,31	0,08	1,16	580	1,90
385	15,16	1,20	0,05	0,25	3,63	0,75	10,88	0,08	1,16	588	1,93
390	15,35	1,20	0,05	0,25	3,63	0,75	10,88	0,08	1,16	595	1,95
395	15,55	1,20	0,05	0,25	3,63	0,75	10,88	0,08	1,16	603	1,98
400	15,75	1,20	0,05	0,24	3,48	0,72	10,44	0,07	1,02	610	2,00
410	16,14	1,20	0,05	0,24	3,48	0,72	10,44	0,07	1,02	625	2,05
420	16,54	1,20	0,05	0,23	3,34	0,69	10,01	0,07	1,02	640	2,10
430	16,93	1,20	0,05	0,23	3,34	0,69	10,01	0,07	1,02	655	2,15
440	17,32	1,20	0,05	0,22	3,19	0,66	9,57	0,07	1,02	670	2,20
450	17,72	1,20	0,05	0,22	3,19	0,66	9,57	0,07	1,02	685	2,25

ADAPTSIL®

Ø INT		WALL THICKNESS		WORKING PRESSURE		BURSTING PRESSURE	
				ISO 1402/2009		ISO 1402/2009	
mm	inch	+1/-0.5mm	+0.04/-0.02"	Bar at 20°C	Psi at 68°F	Bar at 20°C	Psi at 68°F
13	1/2	5,8	0,23	16,1	234	48,3	701
19	3/4	5,8	0,23	14	204	42,1	611
25	1	5,8	0,23	13,4	194	40,1	582
38	1 1/2	5,8	0,23	10,4	151	31,2	453
51	2	5,8	0,23	8,3	120	24,8	360
63	2 1/2	5,8	0,23	6,1	89	18,4	267
76	3	5,8	0,23	4,9	72	14,8	215

VENAFLO® HF

INNER DIAMETER		WALL THICKNESS ISO 1307		WORKING PRESSURE ISO 1402		BENDING RADIUS ISO 1746	
mm	inch	+- 0.8 mm	+- 0.03 inch	Bar at 20°C	Psi at 68°F	mm	inch
10	3/8	6,0	0,24	10	145,04	40	1,58
13	1/2	6,0	0,24	10	145,04	45	1,77
16	5/8	6,0	0,24	10	145,04	55	2,17
19	3/4	6,0	0,24	10	145,04	65	2,56
25	1	6,0	0,24	10	145,04	85	3,35
32	1 1/4	6,0	0,24	10	145,04	120	4,72
38	1 1/2	6,5	0,26	10	145,04	140	5,51
51	2	8,0	0,31	10	145,04	180	7,09
63,5	2 1/2	8,0	0,31	5	72,52	320	12,60
76	3	8,0	0,31	5	72,52	380	14,96
100	4	9,0	0,35	3	43,51	500	19,69

VENAFLO® HF-X

INNER DIAMETER		WALL THICKNESS ISO 1307		WORKING PRESSURE ISO 1402		BENDING RADIUS ISO 1746	
mm	inch	+0,8/ -0,8 mm	+- 0,03 inch	Bar a 20°C	Psi at 68°F	mm	inch
13	1/2	6	0,24	10	145,04	120	4,72
19	3/4	6	0,24	10	145,04	120	4,72
25	1	6	0,24	10	145,04	150	5,91
32	1 1/4	6	0,24	10	145,05	200	7,87
38	1 1/2	6,5	0,26	10	145,05	250	9,84
51	2	8	0,31	10	145,05	300	11,81
63,5	2 1/2	8	0,31	5	72,52	380	14,96
76	3	8	0,31	5	72,52	460	18,11

The following chart is purely informative and does not imply any responsibility of VENAIR. Our specialists are available to advise you on the most suitable hose for any chemical product.

	S	B	V	P		S	B	V	P		S	B	V	P
	SILICONE					SILICONE					SILICONE			
	VENA FOOD / VENA STEAM					VENA FOOD / VENA STEAM					VENA FOOD / VENA STEAM			
	VITOSIL					VITOSIL					VITOSIL			
	VENAFLO					VENAFLO					VENAFLO			
> A: EXCELLENT														
> B: GOOD														
> C: SMOOTH REACTION														
> D: NOT RECOMMENDED														
> E: INCOMPATIBILITY														
A														
acetaldehyde	A	A	D	A	ammonium hydroxide (concentrated)	A	A	B	A	ASTM reference fuel A	D	D	A	A
acetamide	B	A	B	A	ammonium nitrate	E	A	E	A	ASTM reference fuel B	D	D	A	A
acetic acid 5%	A	A	A	A	ammonium nitrite	B	A	E	A	ASTM reference fuel C	D	D	A	A
acetic acid 30%	A	A	B	A	ammonium persulfate solution	E	A	E	A	ATL-857	D	D	A	A
acetic acid, hot high press	C	C	D	A	ammonium persulfate 10%	E	A	E	A	atlantic dominion F	D	D	A	A
acetic acid, glacial	B	B	D	A	ammonium phosphate	A	A	E	A	aurex 903R mobil	D	D	A	A
acetic anhydride	C	B	D	A	ammonium phosphate, mono-basic	A	A	E	A	automatic transmission fluid	D	D	A	A
acetone	B	A	D	A	ammonium phosphate, dibasic	A	A	E	A	automotive brake fluid	C	A	D	A
acetophenone	D	A	D	A	ammonium phosphate, tribasic	A	A	E	A	B				
acetyl acetone	D	A	D	A	ammonium salts	A	A	C	A	bardol B	D	E	A	A
acetyl chloride	C	D	A	A	ammonium sulfate	A	A	A	A	barium chloride	A	A	A	A
acetylene	B	A	A	A	ammonium sulfide	E	A	D	A	barium hydroxide	A	A	A	A
acetylene tetrabromide	E	A	A	A	amyl acetate	D	A	D	A	barium salts	A	A	A	A
acrylonitrile	D	D	D	A	amyl alcohol	D	A	B	A	barium sulfate	A	A	A	A
adipic acid	E	E	E	A	amyl borate	E	D	E	A	barium sulfide	A	A	A	A
aero lubriplate	B	D	A	A	amyl chloride	D	D	A	A	bayol D	D	D	A	A
aero safe 2300	C	A	D	A	amyl chloronaphthalene	D	D	A	A	beer	A	A	A	A
aero safe 2300 w	C	A	D	A	amyl naphthalene	D	D	A	A	beet sugar liquors	A	A	A	A
aero shell IAC	B	D	A	A	anderol L 774 (di-ester)	D	D	A	A	benzaldehyde	D	A	D	A
aero shell 7 A grease	B	D	A	A	anderol L 826 (di-ester)	D	D	A	A	benzene	D	D	A	A
aero shell 17 grease	B	D	A	A	anderol L 829 (di-ester)	D	D	A	A	benzene sulfonic acid	D	D	A	A
aero shell 750	D	D	A	A	ang-25 (glycerol ester)	B	A	A	A	benzine	D	D	A	A
aerozene 50 (50% hydrazine 50% UDMH)					ang-25 (di-ester base)	B	D	A	A	benzochloride	E	A	A	A
air-below 300° F	A	B	A	A	anhydrous ammonia	B	A	D	A	benzoic acid	B	D	A	A
air-above 300° F	A	D	A	A	anhydrous hydrazine	E	B	D	A	benzophenone	E	B	A	A
alkazene	D	D	B	A	anhydrous hydrogen fluo	E	A	D	A	benzyl alcohol	E	B	A	A
alum NH3 CR-K	A	A	D	A	aniline	D	B	C	A	benzyl benzoate	E	B	A	A
aluminum acetate	D	A	D	A	aniline dyes	C	B	B	A	benzyl chloride	D	D	A	A
aluminum bromide	A	A	A	A	aniline hydrochloride	D	C	B	A	black point 77	C	A	A	A
aluminum chloride	B	A	A	A	aniline oils	D	B	C	A	black sulphate liquors	B	B	A	A
aluminum fluoride	B	A	A	A	animal fats	B	B	A	A	blast furnace gas	A	D	A	A
aluminum nitrate	B	A	A	A	animal oil (lard oil)	B	B	A	A	bleach solution	B	A	A	A
aluminum phosphate	A	A	A	A	AN-03 grade M	B	D	A	A	borax	B	A	A	A
aluminum salts	A	A	A	A	AN-0-6	D	D	A	A	bordeaux mixture	B	A	A	A
aluminum sulfate	A	A	A	A	AN-0-366	D	D	A	A	boric acid	A	A	A	A
ambrex 33 mobile	D	D	A	A	AN-V V-0-366 b hydrofluid	D	D	A	A	boron fluids (HEF)	D	D	A	A
amines, mixed	B	B	D	A	ansul ether	D	C	D	A	brake fluid (non petroleum)	C	A	D	A
ammonia anhydrous(liquid)	C	A	D	A	aqua regia	D	C	B	A	bray GG-130	D	D	A	A
ammonia gas, cold	A	A	D	A	argon	B	A	A	A	brayco 719-R (VV-H-910)	B	A	D	A
ammonia gas, hot	A	B	D	A	aroclor 1248	B	B	A	A	brayco 885 MILL-L-6085 A	D	D	A	A
ammonia & lithium metal solution	D	B	D	A	aroclor 1254	C	B	A	A	brayco 910	D	A	D	A
ammonium carbonate	E	A	E	A	aroclor 1260	A	E	A	A	bret 710	D	A	D	A
ammonium chloride	E	A	A	A	aromatic fuel 50%	D	D	A	A	brine	E	A	E	A
					arsenic acid	A	A	A	A	brom-113	D	D	E	A
					arsenic trichloride	E	E	E	A	brom-114	D	D	B	A
					askatel	D	D	A	A	bromine	D	D	A	A
					asphalt	D	D	A	A	bromine anhydrous	C	E	A	A
					ASTM oil #1	A	D	A	A	bromine pentafluoride	D	D	D	A
					ASTM oil #2	D	D	A	A	bromine trifluoride	D	D	D	A
					ASTM oil #3	C	D	A	A	bromine water	D	D	A	A
					ASTM oil #4	D	D	A	A	bromobenzene	D	D	A	A

	S	B	V	P		S	B	V	P		S	B	V	P
					dowtherm oil	B	D	A	A					
					dowtherm A or E	D	D	A	A					
					dowtherm 209.50%solution	C	A	D	A					
					driking water	A	A	A	A					
					dry cleaning fluids	D	D	A	A					
					DTE light oil	D	D	A	A					
					E									
					elco 28-EP lubricant	B	D	A	A					
					epichlorohydrin	D	B	D	A					
					epoxy resins	E	A	D	A					
					esam-6 fluid	E	A	D	A					
					esso fuel 208	B	D	A	A					
					esso golden gasoline	D	D	A	A					
					esso motor oil	D	D	A	A					
					esso transmission fluid (typeA)	D	D	A	A					
					esso WS3812 (MIL-L-7808 A)	D	D	A	A					
					esso SP90-EP lubricant	D	D	A	A					
					esstic 42,43	B	D	A	A					
					ethane	D	D	A	A					
					ethanol	A	A	A	A					
					ethanol amine	B	B	D	A					
					ethers	D	C	C	A					
					ethyl acetate-organic ester	B	B	D	A					
					ethyl acetoacetate	B	B	D	A					
					ethyl acrylate	B	B	D	A					
					ethyl acrylic acid	D	B	E	A					
					ethyl alcohol	B	A	A	A					
					ethyl benzene	D	D	A	A					
					ethyl benzoate	D	D	A	A					
					ethyl bromide	E	D	A	A					
					ethyl cellosolve	D	B	D	A					
					ethyl cellulose	C	B	D	A					
					ethyl chloride	D	A	A	A					
					ethyl chlorocarbonate	D	D	A	A					
					ethyl chloroformate	D	D	A	A					
					ethyl cyclopentane	D	D	A	A					
					ethyl ether	D	C	D	A					
					ethyl formate	E	B	A	A					
					ethyl hexanol	B	A	A	A					
					ethyl mercaptan	C	D	B	A					
					ethyl oxalate	D	D	A	A					
					ethyl pentachlorobenzene	D	D	A	A					
					ethyl silicate	E	A	A	A					
					ethylene	E	E	A	A					
					ethylene chloride	D	D	B	A					
					ethylene chlorohydrin	C	B	A	A					
					ethylene diamine	A	A	D	A					
					ethylene dibromide	D	C	A	A					
					ethylene dichloride	D	C	A	A					
					ethylene glycol	A	D	A	A					
					ethylene oxide	D	C	D	A					
					ethylene trichloride	D	C	A	A					
					ethylmorpholene stannous octoate (50/50)mixture	E	B	D	A					
					F									
					F-60 fluid (dow corning)	D	A	A	A					
					F-61 fluid (dow corning)	D	A	A	A					
					fatty acids	C	D	A	A					
					FC-43 hetacosofluorotri-butylamine	A	A	A	A					
					FC75 fluorocarbon	A	A	B	A					
					ferric chloride	B	A	A	A					
					ferric nitrate	C	A	A	A					
					ferric sulfate	B	A	A	A					
					fish oil	A	A	A	A					
					fluoboric acid	E	A	E	A					
					fluorine (liquid)	D	C	B	A					
					fluorobenzene	D	D	A	A					
					fluorocarbon oils	E	A	E	A					
					fluorolube	A	A	B	A					
					fluorinated cyclic ethers	E	A	E	A					
					fluosilicic acid	E	E	E	A					
					formaldehyde	B	A	D	A					
					formic acid	B	A	C	A					
					freon,11	D	D	A	A					
					freon,12	D	B	B	A					
					freon, 12&ASTM-oil#2 (50/50 mixture)	D	D	A	A					
					freon, 12&SUNISO 4G (50/50 mixture)	D	D	A	A					
					freon,13	D	A	A	A					
					freon, 13B1	D	A	A	A					
					freon,14	D	A	A	A					
					freon,21	D	D	D	A					
					freon,22	D	A	D	A					
					freon,22&ASTM OIL#2D (50/50 mixture)	B	B	A	A					
					freon,31	E	A	D	A					
					freon,32	E	A	D	A					
					freon,112	D	D	A	A					
					freon, 113	D	D	B	A					
					freon,114	D	A	B	A					
					freon,114B2	D	D	B	A					
					freon,115	D	A	B	A					
					feron,142b	E	A	D	A					
					freon,152a	E	A	D	A					
					freon, 218	E	A	A	A					
					freon, C316	E	A	E	A					
					freon, C318	E	A	A	A					
					freon, 502	E	A	B	A					
					freon, BF	D	D	A	A					
					freon, MF	D	D	B	A					
					freon, TF	D	D	B	A					
					freon, TA	A	A	C	A					
					freon, TC	D	B	A	A					
					freon, TMC	C	B	A	A					
					freon, t-P35	A	A	A	A					
					freon, T-WD602	D	B	A	A					
					freon, PCA	D	D	B	A					
					fuel oil	D	D	A	A					

	S	B	V	P
	SILICONE			
	VENA FOOD / VENA STEAM			
	VITOSIL			
	VENAFLO			
fuel oil acidic	A	D	A	A
fuel oil #6	A	D	A	A
fumaric acid	B	E	A	A
fuming sulphuric acid (20/25% oleum)	D	D	A	A
furan (fufuran)	E	C	E	A
fufural	D	B	D	A
fufuraldehyde	D	B	D	A
fufuraldehyde	D	B	D	A
fufuralyl alcohol	D	B	E	A
furyl carbinol	D	B	E	A
fyrquel A60	C	B	D	A
fyrquel 90, 100, 150, 220, 300 500	A	A	A	A
G				
galic acid	E	B	A	A
gasoline	D	D	A	A
gelatin	A	A	A	A
grilling brake fluid	E	A	D	A
glacial acetic-acid	B	B	D	A
glauber's salt	E	B	B	A
glucose	A	A	A	A
glue (depending on type)	A	A	A	A
glycerine-glycerol	A	A	A	A
glycols	A	A	A	A
green sulphate liquor	A	A	A	A
gulfcrown grease	D	D	A	A
gulf endurance oils	D	D	A	A
gulf FR fluids (emulsion)	D	D	A	A
gulf FRG-fluids	A	A	A	A
gulf FRp-fluids	A	B	B	A
gulf harmony oils	D	D	A	A
gulf high temperature grease	D	D	A	A
gulf lesion oils	D	D	A	A
gulf paraount oils	D	D	A	A
gulf security oils	D	D	A	A
H				
halotane	D	D	A	A
halowax oil	D	D	A	A
hannifin lube A	B	D	A	A
heavy water	A	A	E	A
HEF-2 (high energy fuel)	D	D	A	A
helium	A	A	A	A
N-heptane	D	D	A	A
N-hexaldehyde	B	B	D	A

	S	B	V	P
hexane	D	D	A	A
N-hexane-1	D	D	A	A
hexyl alcohol	B	C	A	A
high viscosity lubricant U14	A	A	A	A
high viscosity lubricant H2	A	A	A	A
hilo MS #1	C	B	D	A
houghto-safe271 (water and glycol base)	B	A	B	A
houghto-safe 620(water/ glycol)	B	A	B	A
houthto-safe 1010 phosphate ester	C	A	A	A
houghto-safe 1055 phosphate ester	C	A	A	A
houghto-safe 1120 phosphate ester	C	A	A	A
houghto-safe 5040 (water/ oil emulsion)	C	D	A	A
hydraulic oil (petroleum-base)	C	D	A	A
hydrazine	C	A	E	A
hydrobromic acid	D	A	C	A
hydrobromic acid 40%	D	A	A	A
hydrocarbons (saturated)	D	D	A	A
hydrochloric acid hot 37%	D	C	A	A
hydrochloric acid cold 37%	B	A	A	A
hydrochloric acid 3 molar	D	A	A	A
hydrochloric acid concentrated	D	C	A	A
hydrocyanic acid	C	A	A	A
hydro-drive, MIH-50 (petroleum base)	B	D	A	A
hydro-drive, MIH-10 (petroleum base)	B	D	A	A
hydrofluoric acid, 65% max. cold	D	A	A	A
hydrofluoric acid, 65% min. cold	D	C	A	A
hydrofluoric acid, 65% max. hot	D	D	C	A
hydrofluoric acid, 65% min. hot	D	D	C	A
hydrofluosilicic acid	D	A	A	A
hydrogen gas, cold	C	A	A	A
hydrogen gas, hot	C	A	A	A
hydrogen peroxide (1)	A	A	A	A
hydrogen 90% (1)	B	C	B	A
hydrogen sulfide dry, cold	C	A	D	A
hydrogen sulfide dry, hot	C	A	D	A
hydrogen sulfide wet, cold	C	A	D	A
hydrogen sulfide wet, hot	C	A	D	A
hydrolube-water/ethylene glycol	B	A	A	A
hydroquinone	E	D	D	A
hydyne	D	A	D	A
hyjet	E	A	D	A
hyjet III	E	A	D	A
hyjet S	E	A	D	A
hyjet W	E	A	D	A
hydrochlorous	E	B	A	A
I				
industron FF44	D	D	A	A
industron FF48	D	D	A	A

	S	B	V	P
industron FF53	D	D	A	A
industron FF80	D	D	A	A
iodine	E	B	A	A
iodine pentafluoride	D	D	D	A
iodoform	E	A	E	A
isobutyl alcohol	A	A	A	A
iso-butyl N-butyrate	E	A	A	A
isododecane	E	D	A	A
iso-octane	D	D	A	A
isophorone (ketone)	D	A	D	A
isopropanol	A	A	A	A
isopropyl acetate	D	B	D	A
isopropyl alcohol	A	A	A	A
isopropyl chloride	D	D	A	A
isopropyl ether	D	D	D	A
J				
JP 3 (MIL-J-5624)	D	D	A	A
JP 4 (MIL-J-5624)	D	D	A	A
JP 5 (MIL-J-5624)	D	D	A	A
JP 6 (MIL-J-25656)	D	D	A	A
JP X (MIL-J-25604)	D	D	D	A
kel F liquid	A	A	B	A
kerosene	D	D	A	A
keystone #87HX-grease	D	D	A	A
L				
lactams-amino acids	E	B	D	A
lactic acid	A	A	A	A
lacquers	D	D	D	A
lacquer solvents	D	D	D	A
lard, animals fats	B	D	A	A
lavender oil	D	D	A	A
lead acetate	D	A	D	A
lead nitrate	B	A	E	A
lead sulphamate	B	A	A	A
lehigh x 1169	D	D	A	A
lehigh x 1170	D	D	A	A
light greas	D	D	A	A
ligroin (petroleum ether or benzine)	D	D	A	A
lime bleach	B	A	A	A
lime sulphur	A	A	A	A
lindol, hydraulic fluid (phosphate ester type)	C	A	B	A
linoleic acid	B	D	B	A
linseed oil	A	C	A	A
liquid oxygen	D	D	D	A
liquid petroleum gas (LPG)	C	D	A	A
liquimoly	D	D	A	A
lubricating oils, di-ester	D	D	A	A
lubricating oils, petroleum base	D	D	A	A
lye solutions	B	A	B	A
M				
magnesium chloride	A	A	A	A

VENAIR IN THE WORLD



venairtr@venair.com

EUROPE

› VENAIR GMBH NORTH

Emil-Figge-Strasse 80
44227 - Dortmund - GERMANY
T: (+49) 0231 97424490
kontakt@venair.com

› VENAIR GMBH EAST

Rhinstraße 84
D-12681 Berlin - GERMANY
T: +49 (0) 30 549 865 06
kontakt@venair.com

› VENAIR GMBH SOUTH

Robert-Bosch-Strasse 3
71691 - Freiberg am Neckar - GERMANY
T: +49 (0) 07141 9748653
kontakt@venair.com

› VENAIR SARL

Champ Perrier
Parc du Grand Lyon
01700 - Neyron - FRANCE
T: +33(0) 437 85 08 60
contact@venair.com

› VENAIR SARL WEST

Immeuble SKYLINE 22
Mail Pablo Picasso
44000 Nantes - FRANCE
contact@venair.com

› VENAIR LTD

Unit 50, Gateway 49 Trade Park
Kerfoot Street, Warrington WA2 8NT
UNITED KINGDOM
T: (+44) 01925 629 617
uksales@venair.com

› VENAIR SWEDEN

Hälsingegatan, 45
11331 - Stockholm - SWEDEN
T: +46 (0) 730 8878 45
sesales@venair.com

› VENAIR ESPAÑA SLU

Cerdanya, 26 - Pol. Ind. Nord
08226 - Terrassa - SPAIN
T: (+34) 937 364 861
esventas@venair.com

› VENAIR SRL NORTH

Viale del Fontanone, scn
Zona Industriale 15040 - Castelletto
Monferrato (AL) - ITALY
T: (+39) 0131 1710737
T: (+39) 0131 1926962
commerciale@venair.com

› VENAIR SP. Z O.O. (Warsaw)

Grzybowska 80/82 lok.
700 00-844 Warszawa
T: (+39) 331 8180847
plsales@venair.com

› VENAIR ÜRÜNLER

Venair Silikon Ürünler Mühendislik Ltd.
Şti.
Görükle Mah. Fırat (490) Cad. 19A Nilü-
fer/Bursa - TURKEY
T: (+90) 850 224 7747

› VENAIR O.O.O

Ul. Novgorodskaya, 1
Building 5 - Office B420
127576 - Moscow - RUSSIA
T: (+7) 499 490 06 83
rusales@venair.com

› VENAIR MANUFACTURING S.R.L

Ploiesti West Park DN 72, KM 8,
London Street N. 7 Aricestii Rahtivani
107025 Ploiesti (Prahova)
T: +4034422090
rocontact@venair.com

AFRICA

› VENAIR SOUTH AFRICA

1 Bompas Rd (2nd Floor),
Dunkeld West, Johannesburg, 2196
T: (011) 431 3908
zasales@venair.com

NORTH AMERICA

› VENAIR INC (Miami)

16713 Park Centre Blvd
Miami Gardens, FL 33169 - USA
T: (+1) 305 362 8920
usasales@venair.com

› VENAIR INC (Los Angeles)

1693 E Del Amo Blvd
Carson, CA 90746 - USA
T: (+1) 424 785 8858
usasales@venair.com

› VENAIR INC (Philadelphia)

The Navy Yard, Quarters M-2
4601 - South Broad Street
Philadelphia, PA 19112 - USA
T: (877) 329-2672
usasales@venair.com

› VENAIR INC (Dallas)

7460 Warren Parkway, Ste. 100 #148
Frisco, TX 75034
M: (+1) 305 776 3915

CENTRAL AMERICA

› VENAIR MEXICO

Godard, 108 col. Héroes de Nacozári
Gustavo A. Madero
Ciudad de México, CP 07780
T: + 52 155 5547 7744
mxsales@venair.com

SOUTH AMERICA

› VENAIR EIRELI

Alameda 2° Sargento Fábio Pavani, 282
Jardim Japão - São Paulo - SP
CEP - 02142-040
T: (+55) 11 3213 4968
brsales@venair.com

ASIA

› VENAIR CHINA NORTH

N.88 Jianguo Road, Building D,
Office 3112, SOHO New Town,
Chaoyang District, Beijing - CHINA
T: (+86) 010-86393497
cnsales@venair.com

› VENAIR CHINA MIDDLE

Jiangkai Road 177, Building 3, Floor 1,
Room 02-03, Shanghai - CHINA
T: (+86) 021-60555117
cnsales@venair.com

› VENAIR CHINA SOUTH

Room 1421,14/F, Tower A
China International Centre, n.33,
Zhongshan San Road Yuexiu District,
Guangzhou, 510055 - CHINA
T: (+86) 020-81148395
cnsales@venair.com

› VENAIR INDIA NORTH

CoWorks, RMZ Infinity, 15, Delhi - Jaipur Expy
Sector 18, Gurugram
122008 Haryana, INDIA
T: (+91) 124 662 09 51
insales@venair.com

VENAIR INDIA WEST

Suave Spaces
601, 602 Sunatwala Mark Plazzo,
Hinjawadi, Pune
411057 Maharashtra, INDIA
T: (+91) 9158750222
insales@venair.com

› VENAIR INDIA SOUTH

Survey No. 118/2
80 Feet Main Road, Jakkur Bengaluru
560064 Karnataka, INDIA
T: (+91) 80 2973 6800
insales@venair.com

› VENAIR BIOTECH

Unit A, Floor 2
Standard Factory, Road 14
Tan Thuan EPZ, Tan Thuan Dong Ward
District 7 - Ho Chi Minh City - VIETNAM
T: (+84) 837 700 360
vnsales@vinasil.com

› VENAIR SINGAPORE PTE LTD

110 Lor 23 Geylang Street #04-06
Victory Center
388410 - Singapore - SINGAPORE
T: (+65) 6221 7445
sgsales@venair.com

› VENAIR BANGKOK

T-One Building, 8 Sukhumit, 40 Alley,
Khet Khlong Toei, Phra Kharong,
Bangkok 10110
M: (+66) 98 696 2925
T: (+66) 25 08 89 72

The logo for Venair, featuring the word "VENAIR" in a bold, sans-serif font. The "V" and "A" are connected, and the "I" and "R" are also connected. The letters are dark blue.

MORE THAN HOSES

IMPORTANT:

The Company reserves the right to change, amend, modify, suspend, continue or terminate all or any part of this Catalogue at any time without notice.

It is the user's responsibility to ensure the suitability and safety of the VENAIR products for all intended uses. All the tests must be conducted in accordance with applicable regulatory requirements in order to determine the safety and effectiveness for use of the hoses in any particular application.

Limited Warranty: For a period of 6 months from the date of sale, VENAIR warrants this product to be free from defects in materials and workmanship. Our only obligation will be to replace any portion proving defective, or at our option, to refund the purchase price thereof. User assumes all other risk, if any, including the risk of injury, loss or damage, direct or consequential, arising out of the use, misuse, or inability to use, this product. THIS WARRANTY IS IN LIEU OF THE WARRANTIES OF MERCHANTABILITY, FITNESS FOR PARTICULAR PURPOSE, AND ALL OTHER WARRANTIES, EXPRESSED OR IMPLIED. No deviation is authorized. VENAIR assumes no obligations or liability for any advice furnished by it, or for results obtained with respect to those products. All such advice is given and accepted at the buyer's risk.

Vena, Venair and the Venair logo are trademarks of Venair Ibérica SA.

CAT 45 REV 10 EN-US

Copyright 2020 / Venair Group / All rights reserved®